

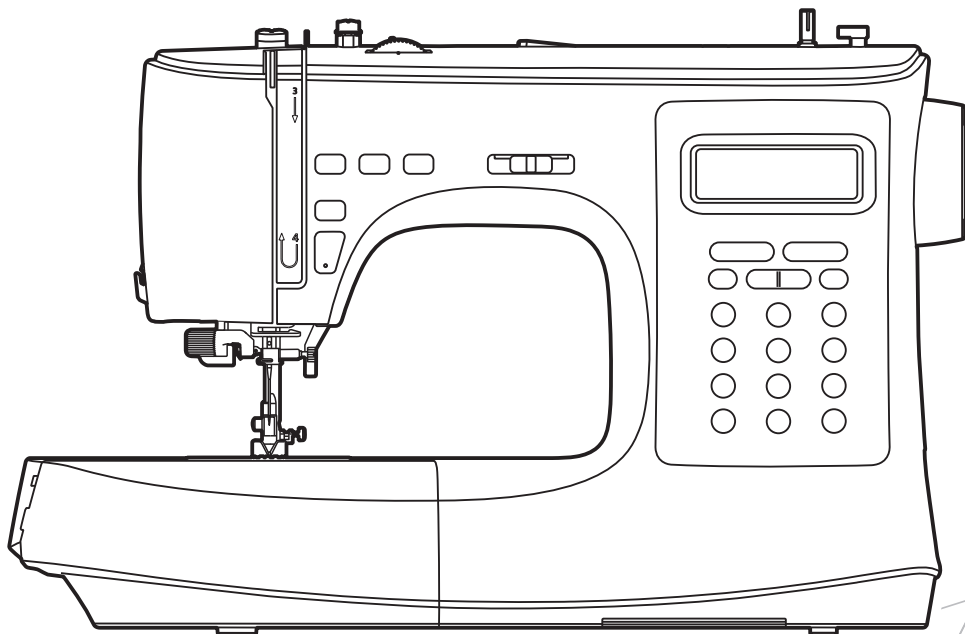

NECCHI

Instruction Manual



NC-103D



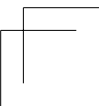
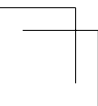

Important safety instructions

When using an electrical appliance, basic safety should always be followed, including the following:

Read all instructions before using this sewing machine.

DANGER - To reduce the risk of electric shock:

1. An appliance should never be left unattended when plugged in.
2. Always unplug this appliance from the electric outlet immediately after using and before cleaning.

WARNING - To reduce the risk of burns, fire, electric shock, or injury to persons:

1. Read the instruction carefully before you use the machine
2. Keep the instructions at a suitable place close to the machine and hand it over if you give the machine to a third party.
3. Use the machine only in dry locations.
4. Never leave the machine unattended with children or elderly people as they may not be able to estimate the risk.
5. This appliance can be used by children aged from 8 years and above and persons with reduced physical, sensory or mental capabilities or lack of experience and knowledge if they have been given supervision or instruction concerning use of the appliance in a safe way and understand the hazards involved.
6. Children shall not play with the appliance.
7. Cleaning and user maintenance shall not be made by children without supervision.
8. Always switch off the machine if you carry out preparation for work (change the needle, feed the yarn through the machine, change the footer, etc.).
9. Always unplug the machine if you leave it unattended, to avoid injury by expediently switch on the machine.
10. Always unplug the machine if you carry out maintenance (oiling, cleaning).
11. Don't use the machine if it's wet or in humid environment.
12. Never pull at the cord, always unplug the machine by gripping the plug.
13. If the LED lamp is damaged or broken, it must be replaced by the manufacturer or it's service agent or a similarly qualified person, in order to avoid a hazard.
14. Never place anything on the pedal.

15. Never use the machine if the air vents are blocked, keep the air vents of the machine and the foot pedal free from dust, fusel and leftovers.
16. The machine must only be used with designated foot controller, in order to avoid a hazard. If the foot controller is damaged or broken, it must be replaced by the manufacturer or its service agent or a similarly qualified person.
17. The sound pressure level at normal operation is smaller than 75dB(A).
18. Do not dispose of electrical appliances as unsorted municipal waste, use separate collection facilities.
19. Contact your local government for information regarding the collection systems available.
20. If electrical appliances are disposed of in landfills or dumps, hazardous substances can leak into the groundwater and get into the food chain, damaging your health and well-being.
21. When replacing old appliances with new ones, the retailer is legally obligated to take back your old appliance for disposal at least for free of charge.
22. The appliance is not to be used by persons (including children) with reduced physical, sensory or mental capabilities, or lack of experience and knowledge, unless they have been given supervision or instruction. (For outside Europe)
23. Children being supervised not to play with the appliance. (For outside Europe)

SAVE THESE INSTRUCTIONS

This sewing machine is intended for household use only.

Be sure to use the sewing machine in the temperature range from 5°C to 40°C. If the temperature is excessively low, the machine can fail to operate normally.

To carry the sewing machine, hold the carrying handle with your hand, and support the sewing machine with the other hand.

Contents

Machine Introduction

Principal parts of the machine	1
Accessories	2
Standard.....	2
Optional.....	2
Connecting machine to power source	3
Polarized plug information	3
Foot control	3
Foot controller with needle up and down feature.....	3

Machine Setup

Sewing table	5
Free arm.....	5
Two-step presser foot lifter	5
Install the extension table	6
Adjust presser foot pressure	6
Winding the bobbin	7
Inserting the bobbin	9
Threading the upper thread	10
Bringing up the bobbin thread	13
Replacing the needle	14
Matching needle/fabric/thread	15
Changing the presser foot	16
Remove the presser foot.....	16
Attach the presser foot.....	16
Remove and insert the presser foot holder.....	16
Insert the edge/quilting guide.....	16
To raise or drop the feed dogs	17
Thread tension	18

Instruction

LCD screen	20
Operation buttons	21
Selecting stitch	27
Memory function buttons	28
Memory program	29
Combine stitches.....	29
Recalling and sewing the memorized stitches.....	30
Inserting stitches	30
Editing stitches	31
Clearing stitches	31
Repeat setting	32

Stitch Chart

Stitch chart	34
A-Direct Pattern Group	34
B-Regular Pattern Groups	34
C-Alphabet Group-Block style	36
D-Alphabet Group-Script style	36

Sewing Basics

Straight stitch	38
Changing the needle position	38
Zigzag stitch	39
Starting to sew	40
Useful skills	42
Reverse sewing.....	42
Sewing curves.....	42
Sewing corners	43
Sewing stretch fabrics.....	43
Sewing thin fabrics.....	43
Sewing heavy fabric.....	44

Utility Stitches

Stretch stitch	46
Straight stretch stitch	46
Zigzag stretch stitch	46
Sewing stretch fabrics and elastic tape	47
Overcasting stitch	48
Using the all purpose foot	48
Using the overcasting foot	48
Blind Hem	49
Buttonhole stitch	50
Making a buttonhole on stretch fabrics.....	52
Bar tack stitch	53
Darning stitch	54
Eyelet stitch	56
Button sewing	57
Zipper insertion	58
Inserting a centered zipper	58
Inserting a side zipper.....	59
Satin stitch sewing	60
Gathering	61
Gathered fabric	61
To gather and attach gathered fabric in one step	61
Smocking	62
Free motion darning, embroidery and monogramming	63
Preparation for embroidering and monogramming.....	63
Darning.....	64
Embroidery.....	64
Monogramming	64
Quilting	65
Using the edge/quilting guide.....	65
Joining the pieces of the fabric	65
Patchwork stitching	66
Applique	67
Fagoting	67
Scallop stitch	68
Scallop edging.....	68

Scallop hem	68
Cording.....	69
Single cording	69
Striple cording	69
Narrow hemming.....	70
Twin needle.....	71

Maintenance and Trouble shooting

Maintenance	74
Clean the hook	74
Clean the machine surface	74
Warning Function.....	75
Warning beeping sound	75
Trouble shooting guide	76

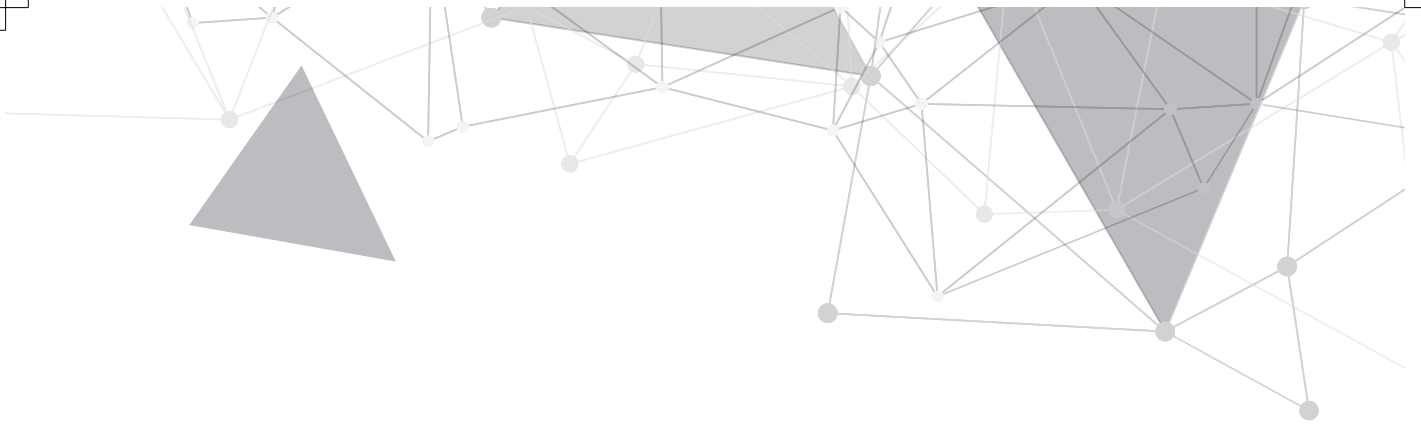

Machine Introduction



Principal parts of the machine

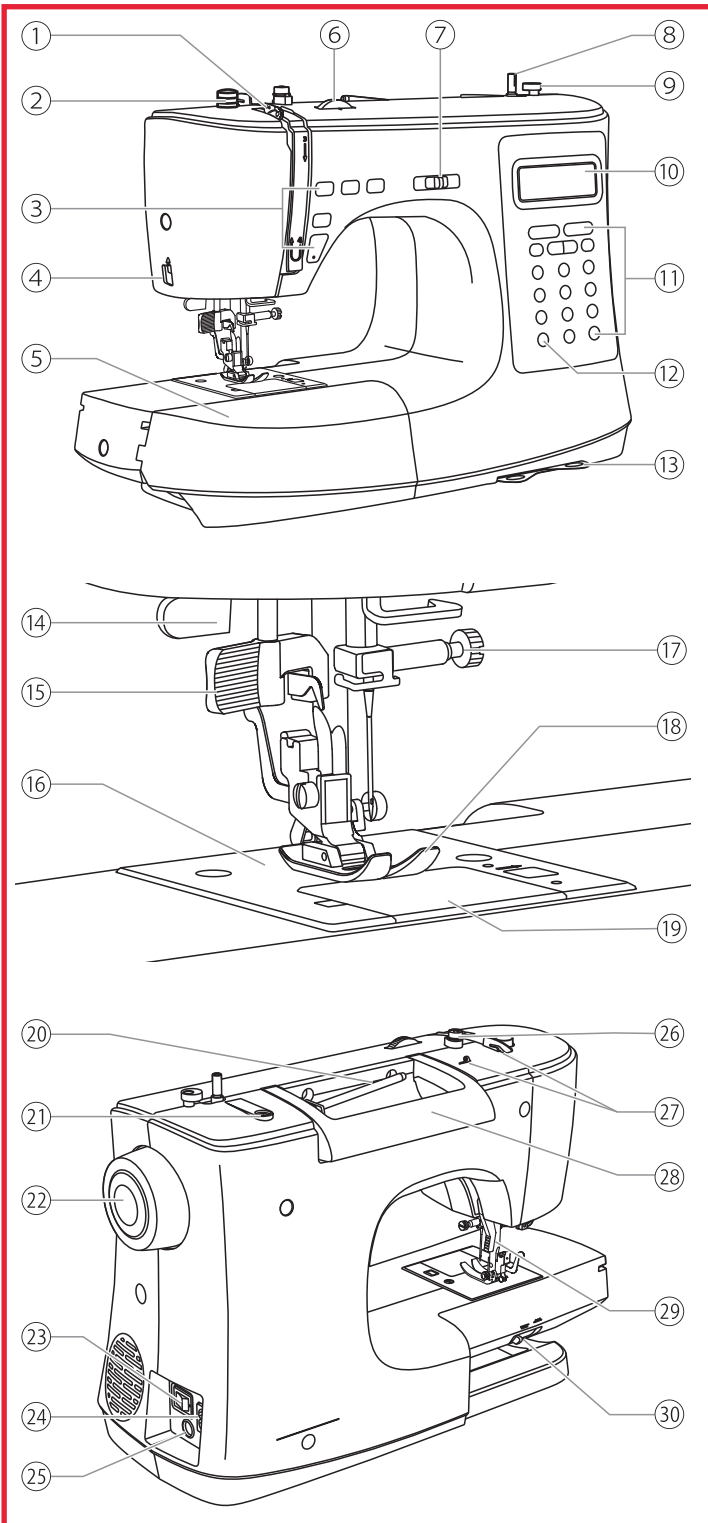

- ① Take-up lever
- ② Presser foot pressure dial
- ③ Operation buttons
- ④ Thread cutter
- ⑤ Sewing table and accessory box
- ⑥ Tension dial
- ⑦ Speed adjustment slide
- ⑧ Bobbin winder spindle
- ⑨ Bobbin winder stopper
- ⑩ LCD screen
- ⑪ Operation buttons
- ⑫ Pattern group switch button
- ⑬ Quick reference plate
- ⑭ Buttonhole lever
- ⑮ Needle threader
- ⑯ Needle plate
- ⑰ Needle clamp screw
- ⑱ Presser foot
- ⑲ Bobbin cover
- ⑳ Horizontal spool pin
- ㉑ Second spool pin hole
- ㉒ Handwheel
- ㉓ Main power switch
- ㉔ Power cord socket
- ㉕ Foot control connector
- ㉖ Bobbin thread guide
- ㉗ Upper thread guide
- ㉘ Handle
- ㉙ Presser foot lifter
- ㉚ Drop feed lever

Accessories

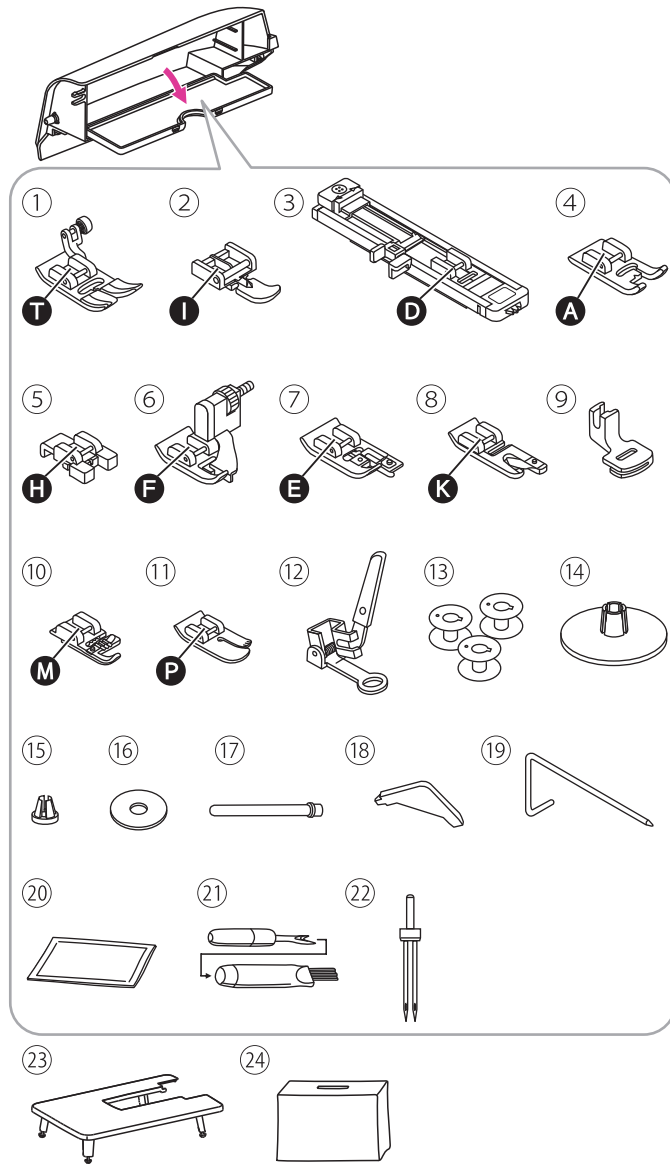

Most accessories are stored in the accessory box. The extension table and soft cover can be found aside of the packing styrofoam.

❖ Standard

- ① All purpose foot (already installed)
- ② Zipper foot
- ③ Buttonhole foot
- ④ Satin stitch foot
- ⑤ Button sewing foot
- ⑥ Blind hem foot
- ⑦ Overcasting foot
- ⑧ Hemmer foot
- ⑨ Gathering foot
- ⑩ Cording foot
- ⑪ Quilting foot
- ⑫ Darning/embroidery foot
- ⑬ Bobbin (4x) (1x already installed)
- ⑭ Spool holder (Large)
- ⑮ Spool holder (Small)
- ⑯ Spool pin felt
- ⑰ Second spool pin
- ⑱ L-screwdriver
- ⑲ Edge/quilting guide
- ⑳ Pack of Needle: 3x single needles (75/11, 90/14, 100/16)
- ㉑ Seam ripper/brush
- ㉒ Twin needle (80/12, 2.5mm distance)
- ㉓ Extension table
- ㉔ Soft cover

❖ Optional

- ㉕ Walking foot

Note

To purchase optional accessories, please consult your local dealer for further information.

Connecting machine to power source

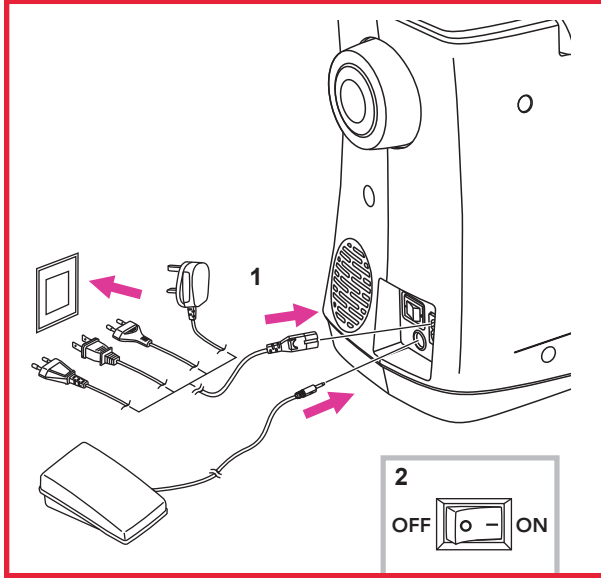

⚠ Attention

Always make sure that the machine is unplugged from power source and the main switch is off ("O"), when the machine is not in use and before inserting or removing parts.

Before connecting the power supply, make sure that the voltage shown on the rating plate is conforming with your main power.

Put the machine on a stable table.

1. Connect the machine to a power source as illustrated.
2. Turn the power switch to on ("I").

The sewing lamp will light up when the switch is turned on.

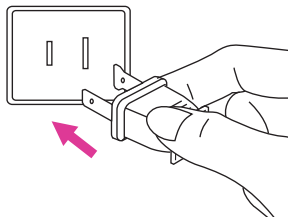

❖ Polarized plug information

This appliance has a polarized plug (one blade is wider than the other), to reduce the risk of electrical shock; this plug will fit in a polarized outlet only one way. If the plug does not fit fully in the outlet, reverse the plug. If it still does not fit, contact a qualified electrician to install the proper outlet. Do not modify the plug in any way.

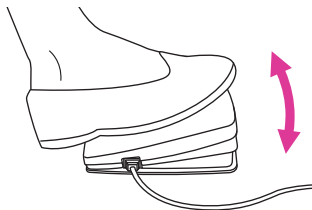

❖ Foot control

When the machine is off, insert the foot control plug into its connector on the machine.

Turn on the machine, and then slowly press down the foot control to start sewing. Release the foot control to stop the machine.

❖ Foot controller with needle up and down feature

User can quickly press one step on the foot controller to change the needle position go up or down into the fabric.

Note

Consult a qualified electrician if in doubt as to connect the machine to the power source.

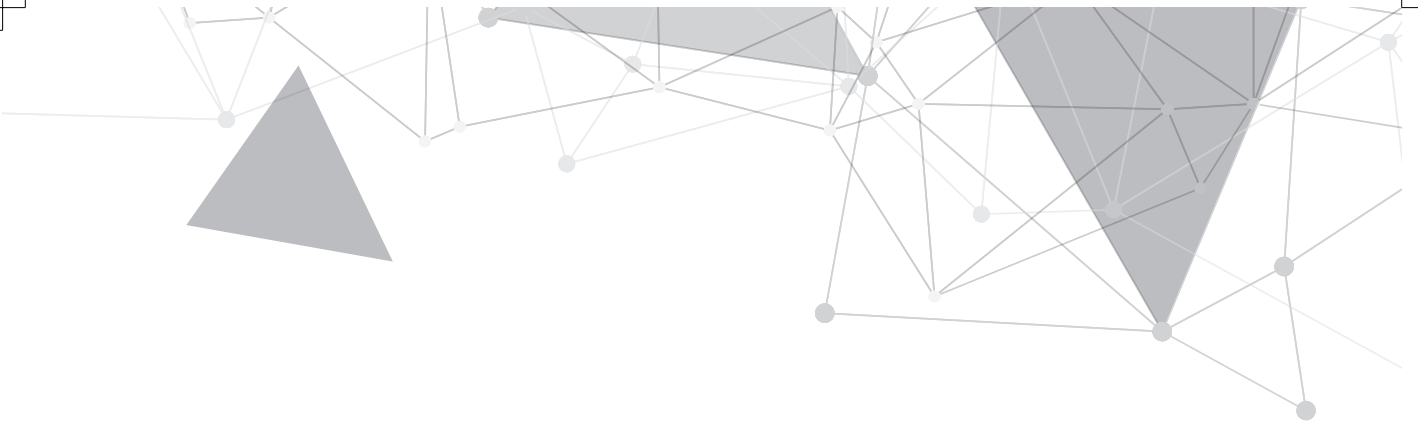

Machine Setup



Sewing table

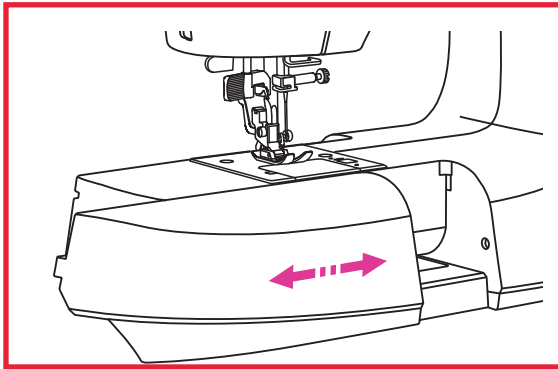

Hold the sewing table horizontally, then pull toward the left to remove it from the machine.

Attach the sewing table, and then push it to the right.

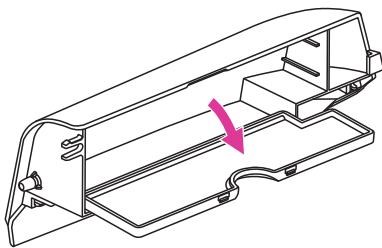

The inside space of the sewing table is used as an accessory box.

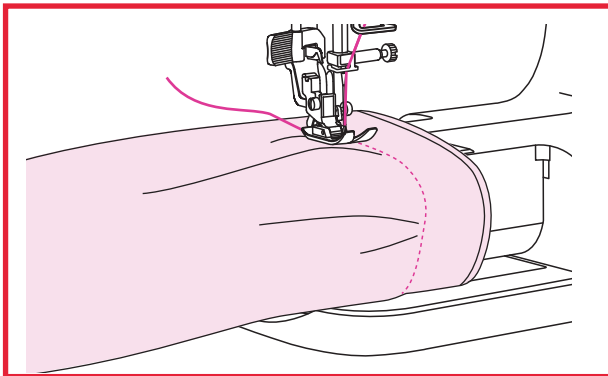

❖ Free arm

Free-arm sewing is convenient for sewing tubular areas such as pant hems and cuffs.

Two-step presser foot lifter

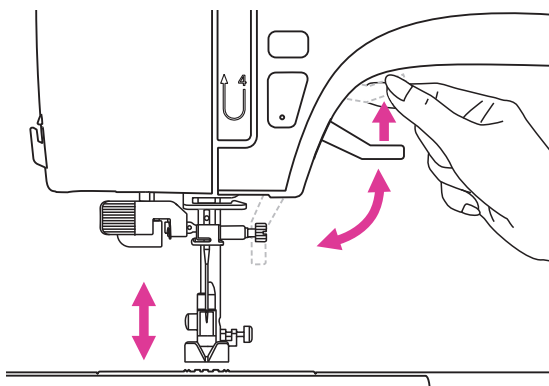

The presser foot lifter is to raise or lower your presser foot.

When sewing multi-layers or thick fabrics, the presser foot can be further raised up manually to allow enough space for your sewing work.

Note

The needle must always be at the highest position.

Install the extension table

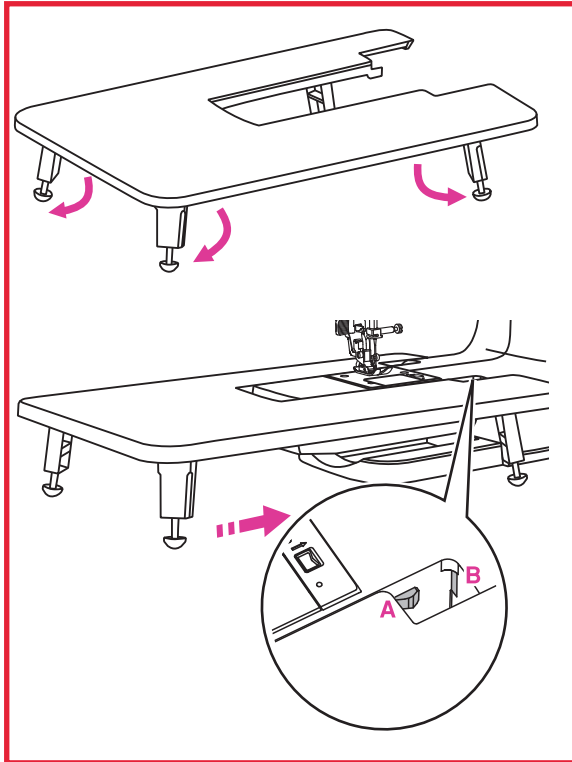

Pull the sewing table and accessory box off by sliding it to the left.

Follow the arrow, and stretch the foot of the extension table.

Snap (A) of the extension table into (B) of the machine.

Adjust presser foot pressure

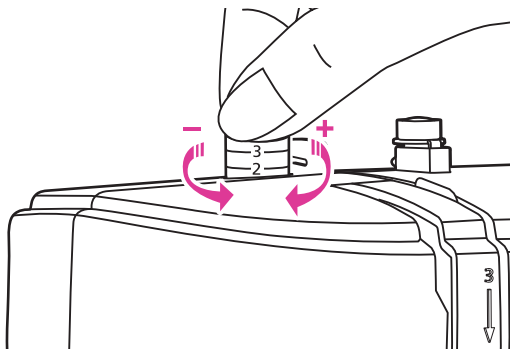

The presser foot pressure dial is on the top left of the face plate.

The presser foot pressure of the machine has been pre-set and requires no particular adjustment for general sewing.

Basic presser foot pressure setting: "2".

For sewing with very thin fabric, reduce the pressure by turning the dial counter-clockwise. If kept turning the dial, it could be take out. By that time, just turn the screw clockwise, it could be locked back and readjust the pressure.

For heavy fabric, increase the pressure by turning it clockwise. Once dial could not be moved any further, it has been reached the bottom, please do not turn any more.

Winding the bobbin

Please following the number order and see the corresponding illustrations below.

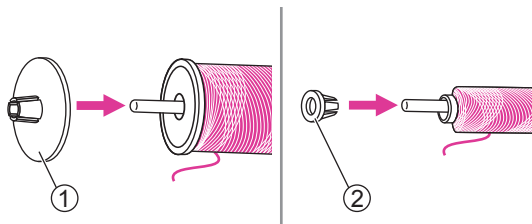
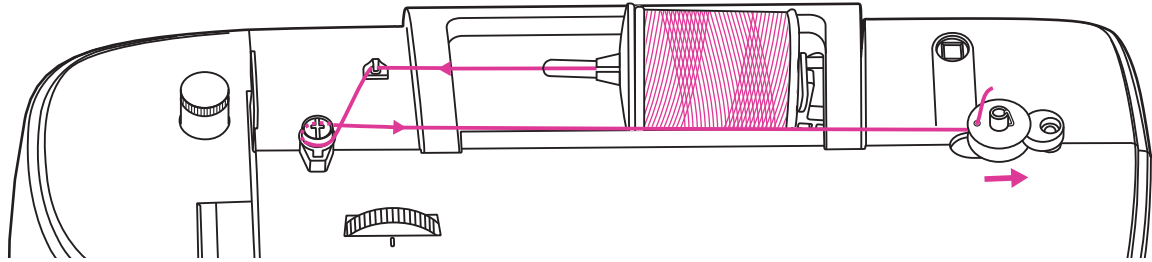

1. Place the thread and spool holder onto the spool pin. For better sewing quality, choose a proper size of the spool holder for the thread and attach it next to the spool.

- ① Large spool holder
- ② Small spool holder

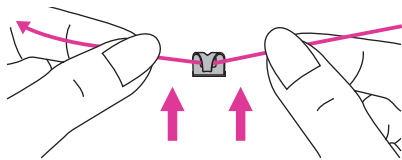

2. Draw the thread from the spool and place the thread in between the upper thread guide.

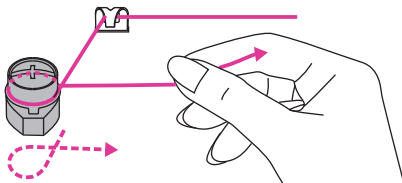

3. Wind the thread clockwise around the tension discs.

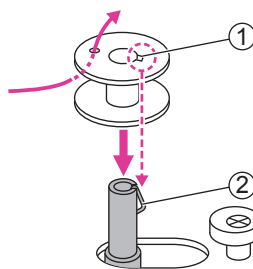

4. Place the thread end through one of the inner holes as illustrated and place the empty bobbin on the bobbin winder spindle. Then align the notch with bobbin winder spindle spring.

- ① Notch
- ② Bobbin winder spindle spring



5. Push the bobbin to the right. When the bobbin winder spindle is pushed to the right, the screen will display the figure.

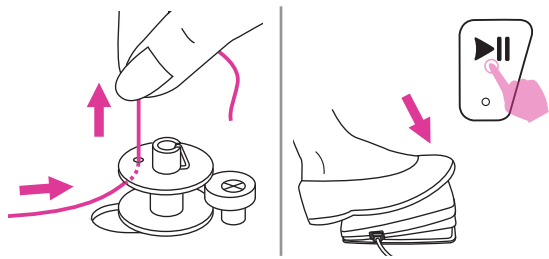

6. Hold the thread tail securely in one hand. Step on the foot control or press the start/stop button to start winding the bobbin.

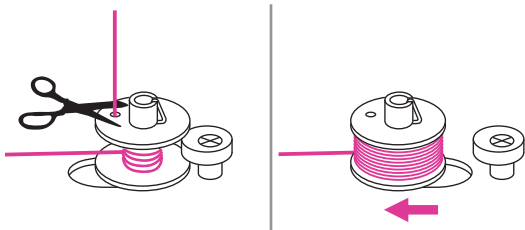

7. After the bobbin has wound a few rounds, stop the machine and cut the thread near the hole of the bobbin. Continue filling the bobbin until it is full. Once the bobbin is full, it rotates slowly. Release the foot control or press the start/stop button to stop the machine, then push the bobbin winder spindle to the left.

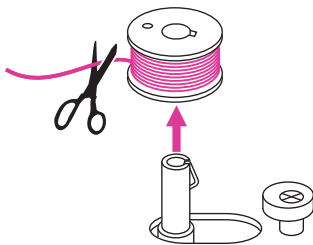

8. Cut the thread and then remove the bobbin.

Note

When the bobbin winder spindle is pushed to the right position, it's in "bobbin winding" mode and the machine is not allowed to sew and the handwheel will not be able to turn. To start sewing, push the bobbin winder spindle back to the left.

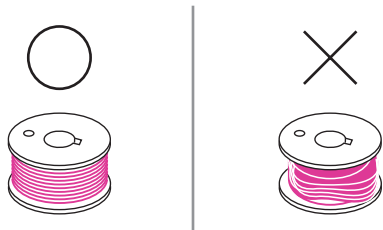

Note

Use a bobbin that has been correctly wound with thread, otherwise the needle may break or the thread tension will be incorrect.

Inserting the bobbin

⚠ Attention

Turn the power switch to off ("O").

When inserting or removing the bobbin, the needle and the presser foot must be fully raised.

Open the bobbin cover by pushing the release button to the right.

① Release button

Insert the bobbin in the bobbin case with the thread running in a counter-clockwise direction (arrow).

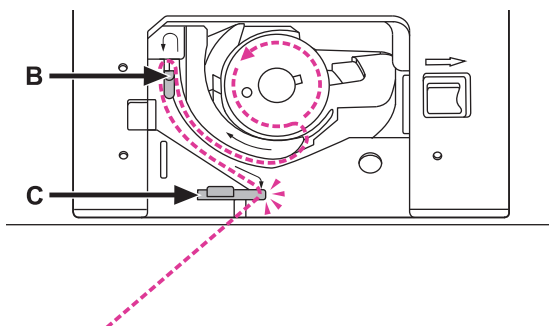
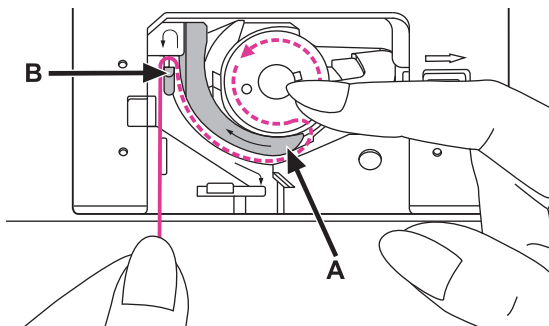
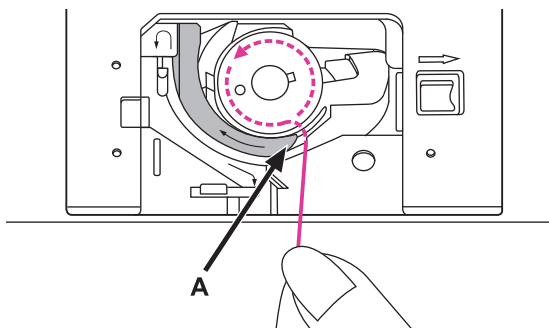
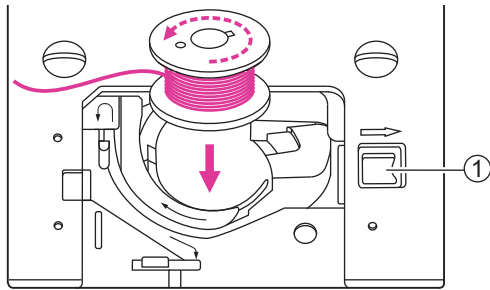

Pull the thread through the slit (A).

With a finger hold gently on top of the bobbin, please follow the arrow markings and draw the thread into the bobbin thread guide from (A) to (B).

Pull the thread at the arrow markings into the stitch plate thread guide from (B) to (C).

To cut off excessive thread, pull it back to the cutter at point (C).

Close the bobbin cover.

Threading the upper thread

Please following the number order and see the corresponding illustrations below. It is important to carry out the threading correctly to get a quality sewing. Otherwise several problems will occur.

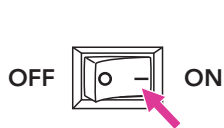
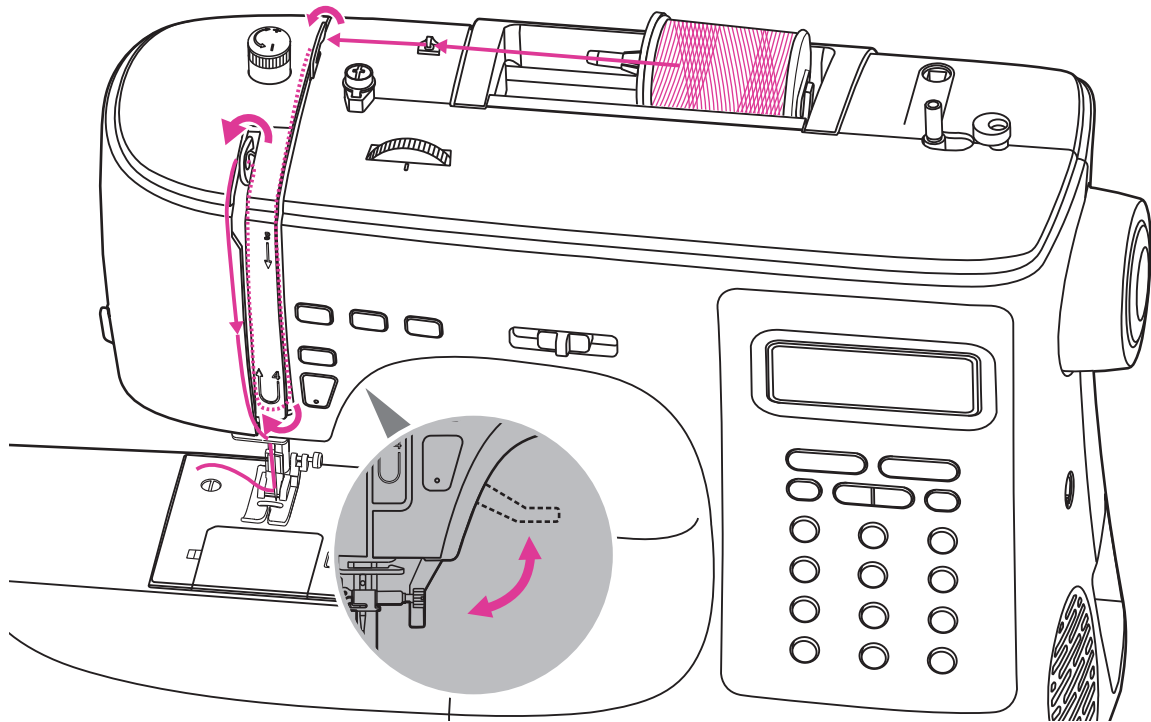

1. Turn the power switch to on ("I"). Raise the presser foot lifter.

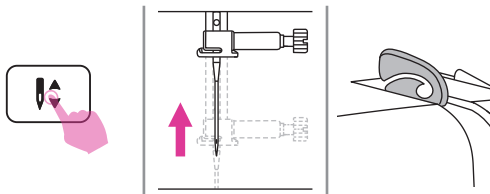

2. Press the needle up/down position button to bring the needle and take-up lever to highest position.

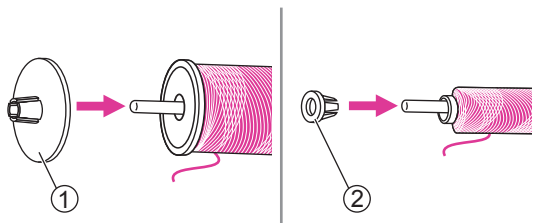

3. Place the thread and spool holder onto the spool pin. For better sewing quality, choose a proper size of the spool holder for the thread and attach it next to the thread.

- ① Large spool holder
- ② Small spool holder

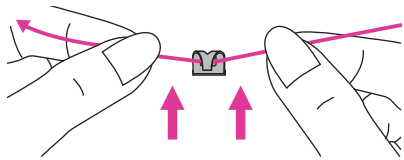

4. Draw the thread from the spool and place the thread in between the upper thread guide.

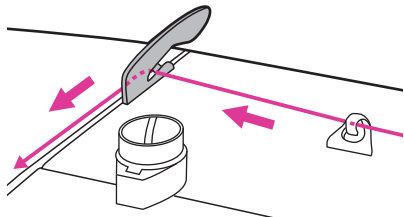

5. Guide the thread ahead and pull the thread through the pre-tension spring as illustrated.

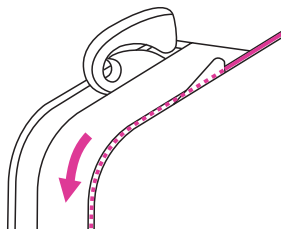

6. Continue to guide the thread into the silver discs to keep the thread in proper tension.

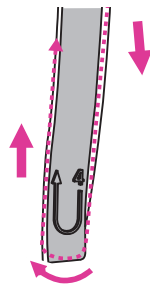

7. Pass the thread under the take-up spring then pull it upwards as arrow marks illustrated.

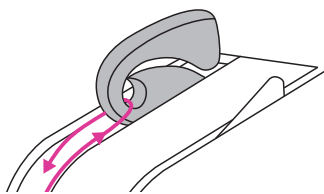

8. Pull the thread to the top then pass the thread through the slotted eye of the take-up lever. Guide the thread down afterwards.

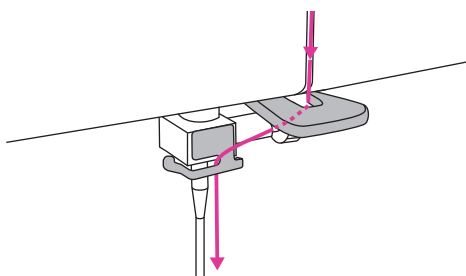

9. Pass the thread behind the flat, horizontal thread guide. Use the needle threader to thread the needle.



10. Lower the presser foot lifter.

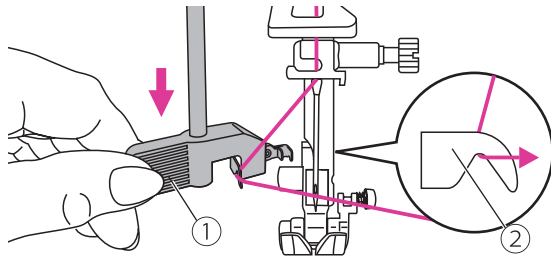

11. Lower the needle threader lever slowly and draw the thread through the thread guide as illustrated and then to the right.

- ① Lever
- ② Hook pin

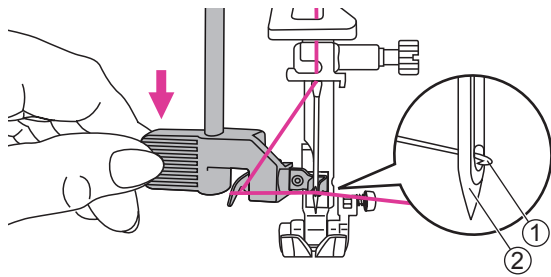

12. The needle threader automatically turns to the threading position and the hook pin passes through the needle eye.

- ① Hook pin
- ② Needle

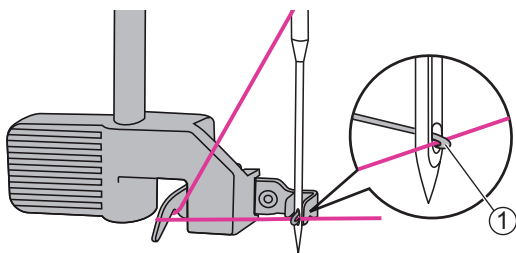

13. Take the thread in front of the needle.

- ① Hook pin

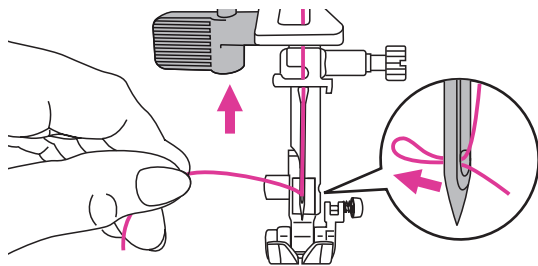

14. Hold the thread loosely and release the lever slowly. The hook turns and passes the thread through the needle eye forming a loop.

Pull the thread through the needle eye.

Note

Your machine is threaded and ready for sewing, follow the instructions on "Starting to sew" chapter to start sewing. (Page 40)

Bringing up the bobbin thread

When sewing gathering or smocking stitch, bring up the bobbin thread first as below instruction.

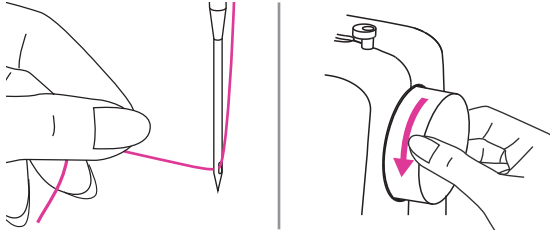

Hold the upper thread with your left hand. Turn the handwheel towards you (counter-clockwise) to lower the needle down below the needle plate then raise it to bring the bobbin thread up.

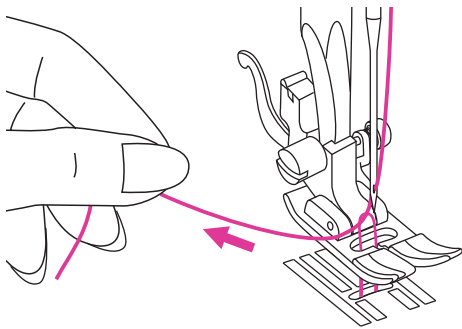

Gently pull on the upper thread to bring the bobbin thread up through the needle plate hole. The bobbin thread will come up in a loop.

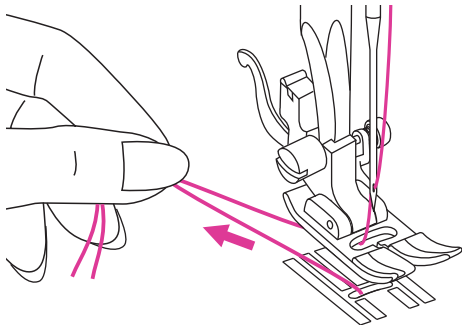

Pull both threads to the back under the presser foot.

Replacing the needle

Change the needle regularly, especially when it shows signs of wear or if it causes problems.

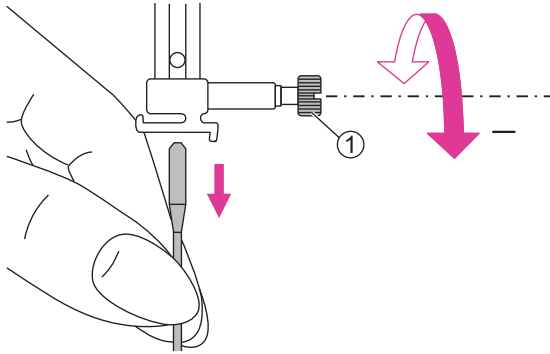

⚠ Attention

Turn the power switch to off ("O") when carrying out below operations!

Turn the handwheel toward you to raise the needle then loosen the needle clamp screw to remove the needle.

① Needle clamp screw

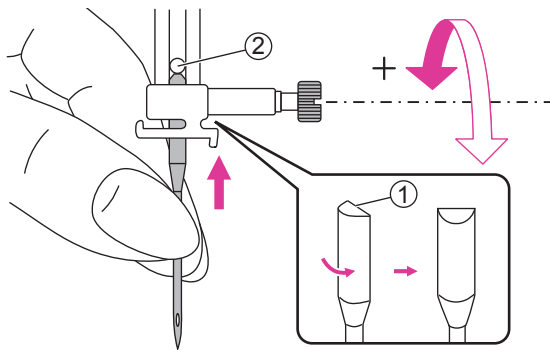

When inserting a new needle, keep the flat side of the shaft to the back.

Push the needle into the clamp until it touches the pin and stops. Then secure it by tightening the needle clamp screw.

① Flat side of the shaft

② Pin

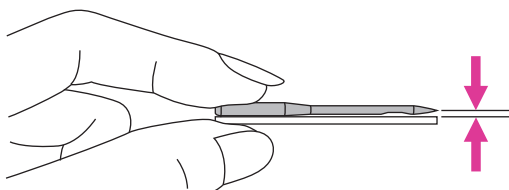

Needles must be in perfect condition.

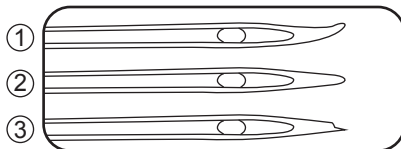





Problems can occur with:

① Bent needles

② Blunt needles

③ Damaged points

Matching needle/fabric/thread

NEEDLE SIZE	FABRICS	THREAD
65/9 - 75/11 	Lightweight fabrics- thin cottons, voile, serge, silk, muslin, Qiana, interlocks, cotton knits, tricot, jerseys, crepes, woven polyester, shirt & blouse fabrics.	Light-duty thread in cotton, nylon, polyester or cotton wrapped polyester.
80/12 	Medium weight fabrics- cotton, satin, kettleclote, sailcloth, double knits, lightweight woolens.	Most threads sold are medium size and suitable for these fabrics and needle sizes. Use polyester threads on synthetic materials and cotton on natural woven fabrics for best results. Always use the same thread on top and bottom.
90/14 	Medium weight fabrics- cotton duck, woolen, heavier knits, terrycloth, denims.	
100/16 	Heavyweight fabrics- canvas, woolens, outdoor tent and quilted fabrics, denims, upholstery material (light to medium).	

Note

1. In general, fine threads and needles are used for sewing fine fabrics, thicker threads and needles are used for sewing heavy fabrics.
2. Always test thread and needle size on a small piece of fabric which will be used for actual sewing.
3. Use the same thread for needle and bobbin.
4. Use a stabilizer or place a backing for fine or stretchy fabrics, and select the correct presser foot.
5. It is recommended that a 90/14 needle should be used when embroidering on heavyweight fabrics or stabilizing products (for example, denim, puffy foam, etc.). A 75/11 needle may bend or break, which could result in injury.
6. For transparent nylon thread, always use needle 90/14 - 100/16. The same thread is usually used for the bobbin thread and upper threading.

Changing the presser foot

⚠ Attention

Turn the power switch to off ("O").

Always use the proper foot for the selected stitch. The wrong foot can cause the needle to break.

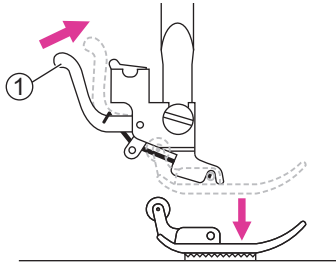

❖ Remove the presser foot

Raise the presser foot lifter. Press the back lever to release the presser foot.

- ① Lever

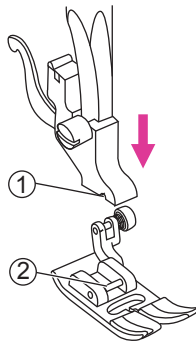

❖ Attach the presser foot

Lower the presser foot lifter until the cut-out meets the pin.

The presser foot will attach to the presser foot holder automatically.

- ① Cut-out
- ② Pin

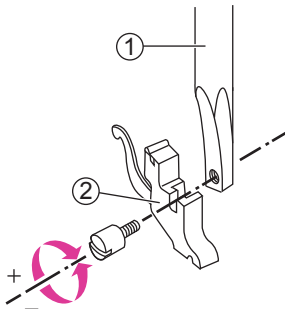

❖ Remove and insert the presser foot holder

Raise the presser foot lifter. Align the presser foot holder with the lower left side of the presser bar. Hold the presser foot holder, then tighten the screw using the enclosed screwdriver.

- ① Presser foot bar
- ② Presser foot holder

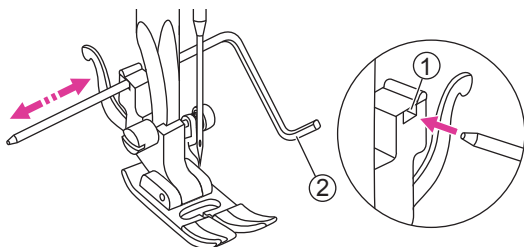

❖ Insert the edge/quilting guide

Insert the edge/quilting guide in the slot as illustrated. Adjust the needed width according to your sewing applications.

- ① Slot
- ② Edge/quilting guide

To raise or drop the feed dogs

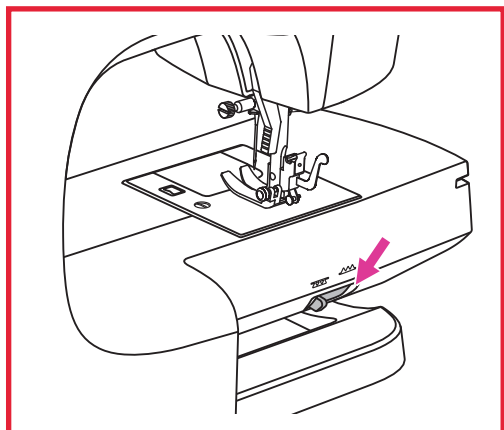

The drop feed lever can be seen on the base at the back side of the sewing machine.

Sliding the drop feed lever to lower or raise the feed dogs. When lever is in raised position, the feed dog will arise automatically when you are sewing.

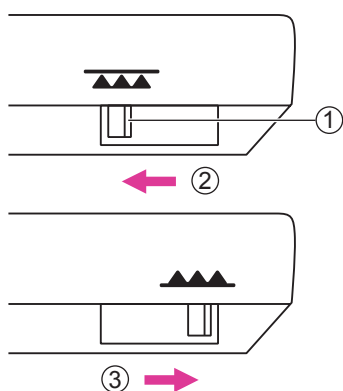

- ① Drop feed lever
- ② Lowered position
- ③ Raised position

Note

When you finish the work, (e.g. button sewing, free motion darning, embroidery and monogramming), please move the drop feed lever to raised position for general sewing purpose.

Thread tension

Proper tension setting is important for sewing. There is no single tension setting appropriate for all the stitch functions and fabrics.

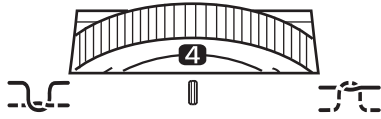

Basic thread tension setting: "4".

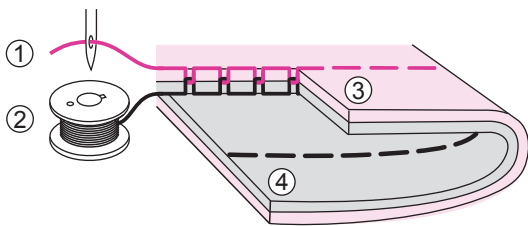

Normal thread tension for straight stitch sewing.

- ① Upper thread
- ② Bobbin thread
- ③ Surface
- ④ Wrong side

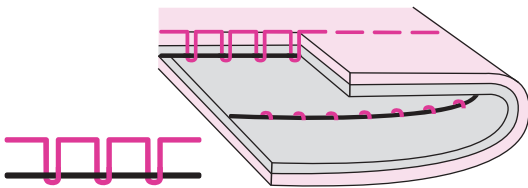

Thread tension is too loose for straight stitch sewing. To increase the tension, press the "+" button.

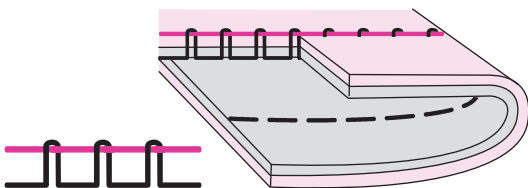

Thread tension is too tight for straight stitch sewing. To reduce the tension, press the "-" button.

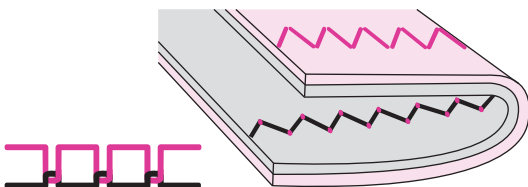

Normal thread tension for zig zag and decorative sewing.

For all decorative sewing you will always obtain a nicer stitch and less fabric puckering.

Correct thread tension is when a small number of the upper thread appears on the bottom side of fabric.



| Instruction



LCD screen

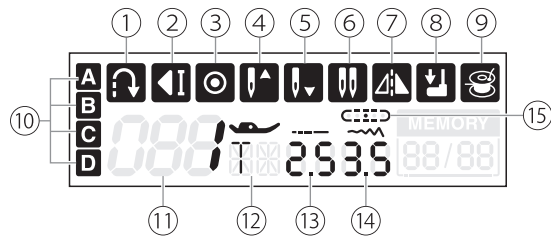

Memory mode:

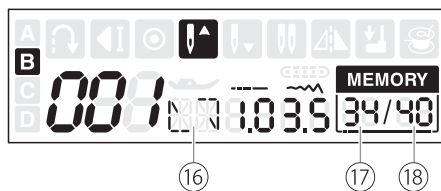

- ① Reverse
- ② Auto-stop
- ③ Auto-lock
- ④ Needle up position
- ⑤ Needle down position
- ⑥ Twin needle mode
- ⑦ Mirror
- ⑧ Buttonhole lever
- ⑨ Bobbin winding
- ⑩ A to D Pattern Group
- ⑪ Stitch number
- ⑫ Suggested presser foot
- ⑬ Stitch length
- ⑭ Stitch width
- ⑮ Needle position
- ⑯ Repeat function
- ⑰ Number of current unit
- ⑱ Total number of unit

Operation buttons

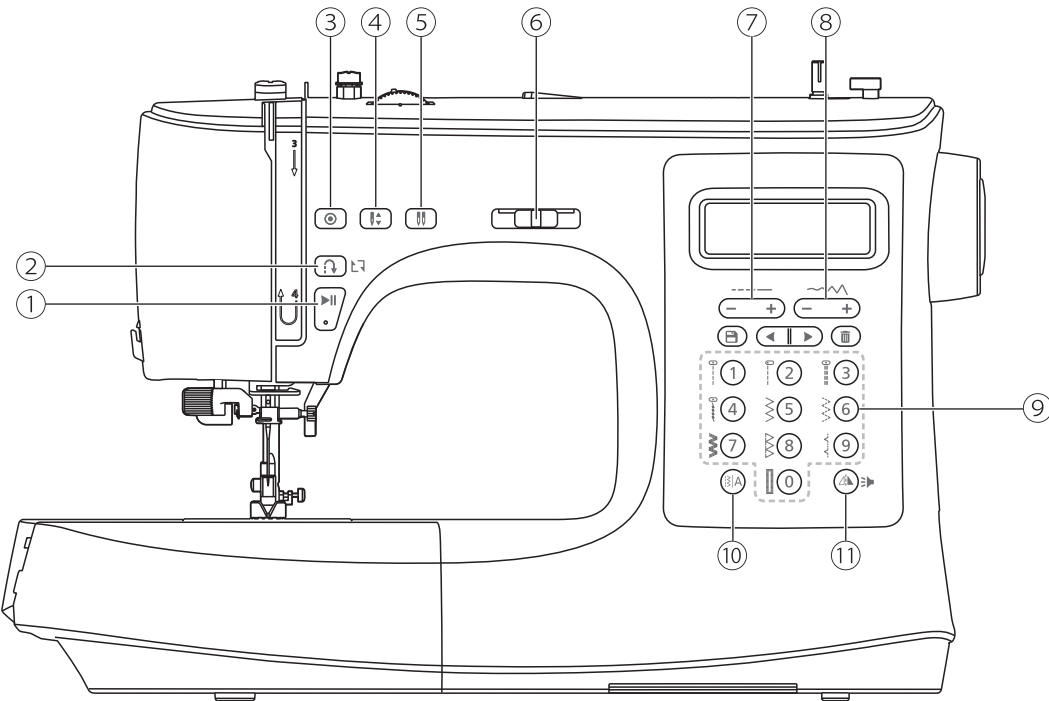

① Start/stop button

Press the start/stop button to start machine running. Press the start/stop button again to stop machine.

This way you may operate the machine without foot control.

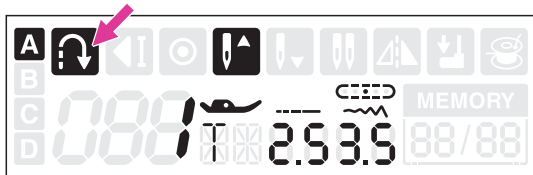

② Reverse button

When the A-Direct Pattern Group number 1-5 or B-Regular Pattern Group number 000 is selected, the machine will sew reverse at a low speed if the reverse button is pressed. The machine will sew forward after the button is released.

When the A-Direct Pattern Group number 6-9 or B-Regular Pattern Group number 001-007 or 021-105 is selected, the machine will immediately sew 3 locking stitches when the reverse button is pressed, then automatically stop.

The LCD screen will display the reverse icon.



② Repeat sewing function (In memory program)

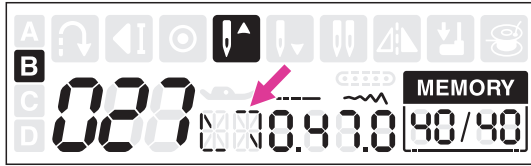

Under the memory program, the reverse button is using for repeat sewing. The stitch combination can be sewn continuously if the icon appeared.

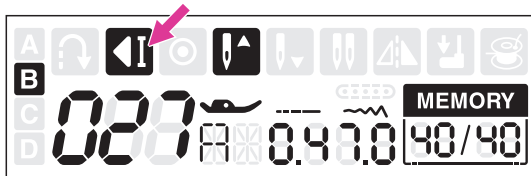

Press the reverse button to cancel the repeat sewing, machine will sew 3 locking stitches at the end of one complete combination. The LCD screen will display the auto-stop icon during sewing the last stitch.



③ Auto-lock button

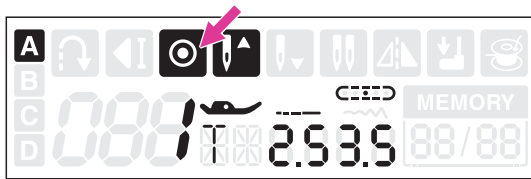

When machine is not sewing: Press the auto lock button, machine will sew 3 stitches in the same position then stop.

During machine is sewing: When A-Direct Pattern Group number 1-5 or B-Regular Pattern Group number 000 is selected, the machine will sew 3 locking stitches if the auto-lock button pressed. Then it will stop automatically.

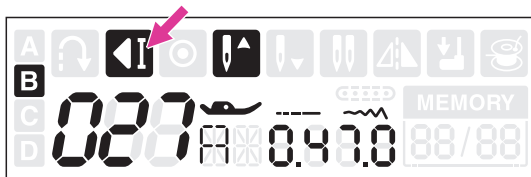

During machine is sewing: When A-Direct Pattern Group number 6-9 or B-Regular Pattern Group number 001-007 or 021-105 is selected, the machine will sew 3 locking stitches at the end of the current stitch if the auto-lock button pressed. Then it will stop automatically. The function can be cancelled if pressed the button once again during sewing.

The auto-lock icon will be disappeared when the current sewing completed.

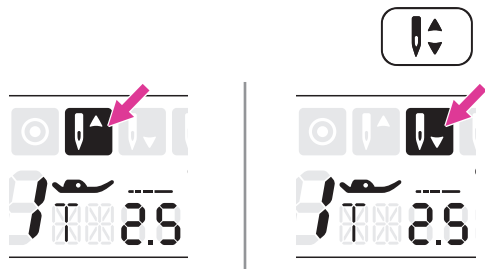

④ Needle up/down position button

With the needle up/down position button, you decide whether the needle stops in the highest or in the lowest position (i.e. in the fabric) when you stop sewing.

Note

During sewing, press the needle up/down position button, it can not to change the needle position.

Press the button so that the arrow on the LCD screen points upward and the needle stops in the highest position. Press the button so that the arrow points downward, the machine stops with the needle in the lowest position.

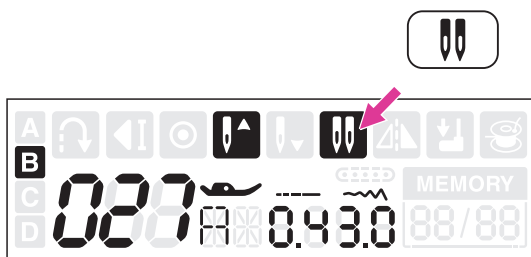

⑤ Twin needle button

Press the twin needle button, the LCD screen will display the twin needle icon.

The machine automatically reduces the maximum width for the twin needle sewing. Please refer to "Twin needle" chapter for more information. (Page 71)

Press the button again to return to single needle sewing.

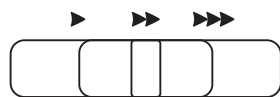

⑥ Speed adjustment slider

The speed adjustment slider can control the sewing speed. To increase the speed, slide the lever to the right. To decrease the sewing speed, slide the lever to the left.

The sewing speed can be adjusted without foot controller.

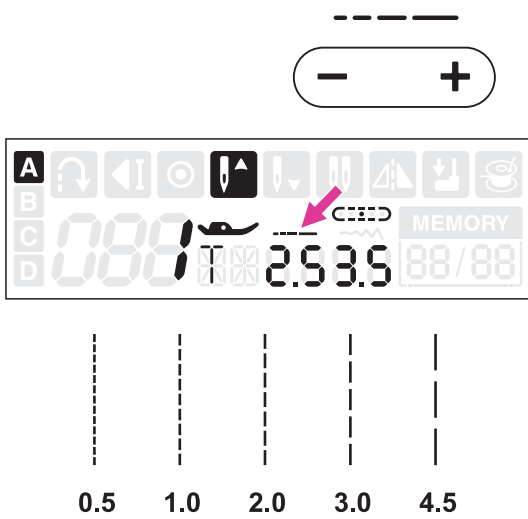

⑦ Stitch length adjustment button

When you select a stitch, the machine will automatically set the recommended stitch length values which will be shown on the LCD screen. The stitch value display will blink 3 times while adjusting to its default setting.

The stitch length can be regulated by pressing the stitch length adjustment buttons. For a shorter stitch, press the "-" button. For a longer stitch, press the "+" button.

Different stitches will have different length limitation.

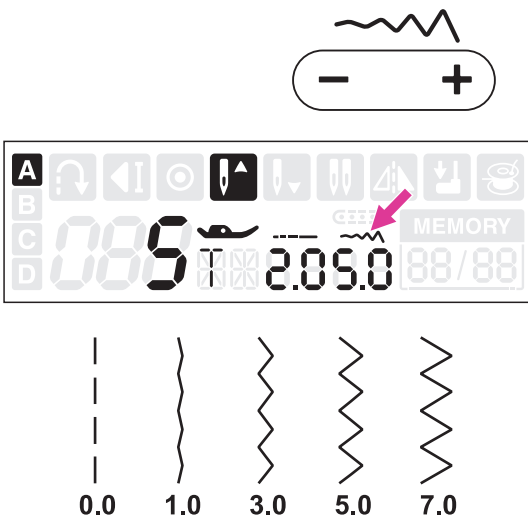

⑧ Stitch width adjustment button

When you select a stitch, the machine will automatically set the recommended stitch width values which will be shown on the LCD screen. The stitch value display will blink 3 times while adjusting to its default setting.

The stitch width can be regulated by pressing the stitch width adjustment buttons. For a narrower stitch, press the "-" button. For a wider stitch, press the "+" button.

Different stitches will have different width limitation.



Needle position adjustment

When the straight stitch is selected, A-Direct Pattern Group number 1-4 or B-Regular Pattern Group number 000 is selected, the needle position can be changed by adjusting the stitch width.

The pre-set position is "3.5", center position.

Press the "+" button, the needle position will be moved to the right. Press the "-" button, the needle position will be moved to the left.

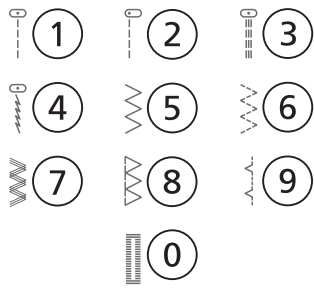

⑨ Direct stitch selection and number buttons

Under A-Direct Pattern Group, press the buttons to select the direct stitches shown beside the number buttons.

Under B-Regular Pattern Group and Alphabet Groups, refer to the stitch pattern plate and use the number buttons 0-9 to select the preference stitches.

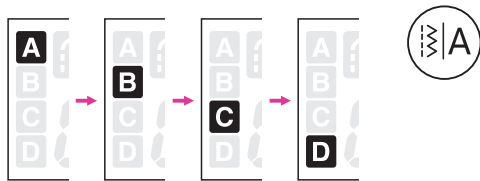

⑩ Pattern group switch button

When machine is turned on, the LCD screen will be set at A-Direct Pattern Group. By pressing the pattern group switch button to select the pattern group:

- A-Direct Pattern Group →
- B-Regular Pattern Group →
- C-Alphabet Group-Block style →
- D-Alphabet Group-Script style →



⑬ Mirror button

The mirror function is to create the horizontal mirror image of selected stitch.

Except the A-Direct Pattern Group number 0, the B-Regular Pattern Group number 008-020, C-Alphabet Group and D-Alphabet Group, the other stitches can be mirror imaged by pressing the mirror button.

The LCD screen will display the mirror icon and the machine will continue to sew the mirror stitch until the mirror button is pressed again.

The mirror function also will be canceled if the stitch changed.

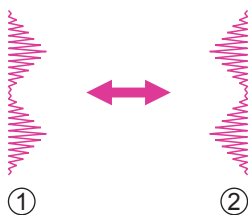

- ① Normal stitch
- ② Mirror image stitch



⑬ Sound button

Buzzer turn off: Press the sound button for 2 seconds and when you hear the machine delivering a short beep, the sound will be turned off.

Buzzer turn on: When machine is in silent mode, press the button for 2 seconds and it will deliver two short beeps to remind you that the sound is turned on now.

Selecting stitch

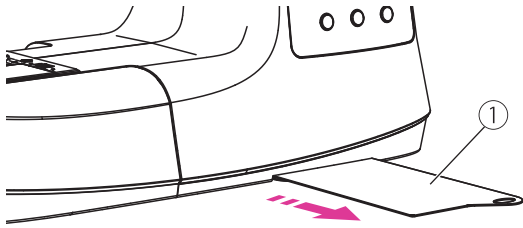

Select the desired stitch from those shown on the stitch pattern plate.

- ① Stitch pattern plate

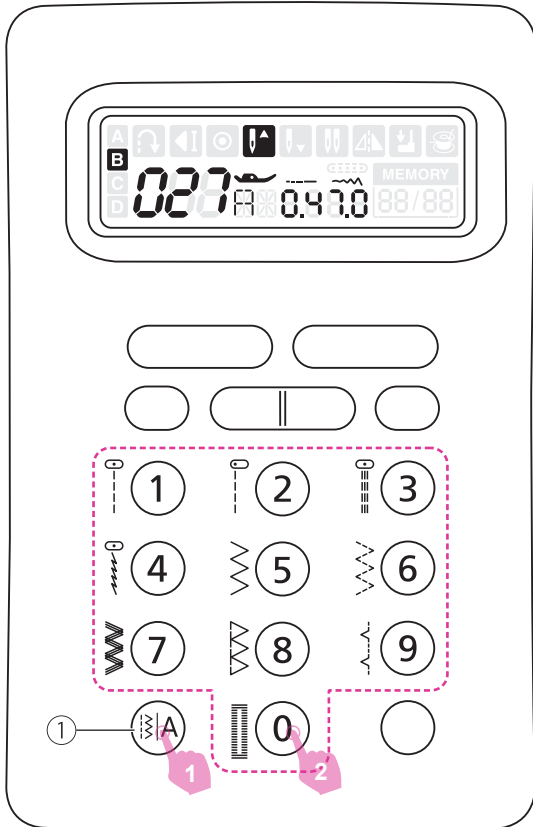

The LCD screen will be set at A-Direct Pattern Group. By pressing the pattern group switch button to select the stitch mode.

- ① Pattern group switch button

Press 2 or 3 digits under the pattern group which selection.

A-Direct Pattern Group:

Use the numeric buttons 0-9 to select the most often used stitches.

B-Regular Pattern Group:

Refer to stitch pattern plate, use the number buttons 0-9 to select the preference stitches.

C-Alphabet Group-Block style:

Refer to stitch pattern plate, use the number buttons 0-9 to select the preference alphanumeric stitches.

D-Alphabet Group-Script style:

Refer to stitch pattern plate, use the number buttons 0-9 to select the preference alphanumeric stitches.

Memory function buttons

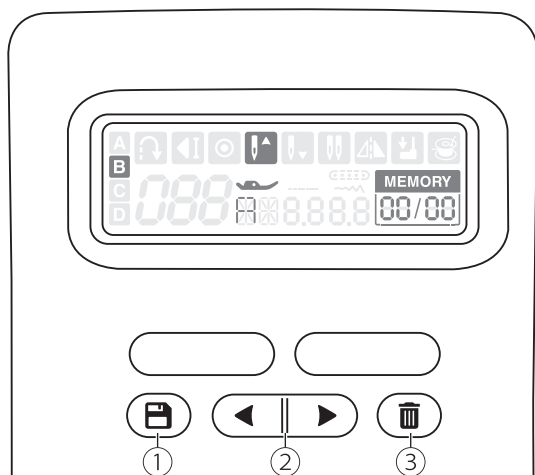

① Memory button

Press the memory button to enter the memory mode, and store the combination of stitches desired. Press the memory button again to leave the memory mode.

② Memory stitch selecting button

Use the arrow button "left" or "right" to selected the memorized stitch.

③ Clear button

Press the clear button to delete the stitch that you want to clear and the next stitch in the back will move forward.

Memory program

You can save frequent-use combining stitches for future use, such as names. Since stored stitches are not lost after the sewing machine is turned off, they can be recalled at any time.

Note

- Multiple stitches selecting from B to D Pattern Groups can be combined and sewn together.
- This machine has 1 program memory and each module can retain 40 units of stitches.
- All the units in the memory can be edited to set it's function such as stitch length, stitch width and mirror.
- B-Regular Pattern Group number 008-020 can not be memorized.

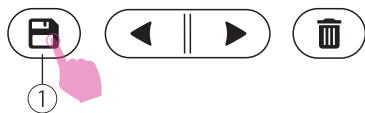
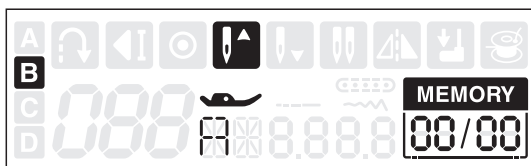

❖ Combine stitches

Turn the power switch to on ("I").

Press the memory button to enter the memory mode. The memory screen appears automatically.

① Memory button

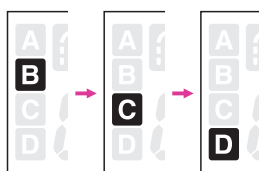

Press pattern group switch button to select the pattern group from B to D.

① Pattern group switch button



Press the desired stitch number directly. (e.g. 023)

The selected stitch number displays on the LCD screen.

Repeat step several times for stitches combination.

Up to 40 characters can be combined in one memory module.

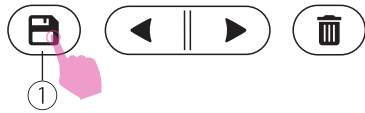

Press the memory button to save the stitches combination, and return to standard sewing mode. Recall the memorized stitches and start to sew.

- ① Memory button

▲ Attention

The selected stitch will be cleared from the memory program after closing the machine if you do not press the memory button again when you have completed your selection.

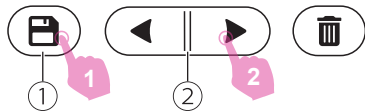
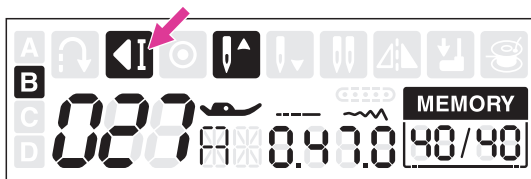

❖ Recalling and sewing the memorized stitches

Press the memory button to enter the memory mode.

Scroll memory stitch selecting button "left" or "right" repeatedly, the LCD will display the stitch numbers and the settings that have been stored one by one.

- ① Memory button
- ② Memory stitch selecting button

Note

The last stitch will be tied off automatically under the memory mode.

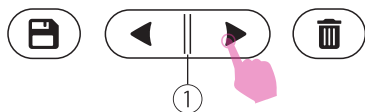

❖ Inserting stitches

Use the memory stitch selecting button "left" or "right" move prior to the stitch you left out. Then select the pattern group and stitch you would like to add, the stitch number you have selected is displayed, then add the new stitch.

- ① Memory stitch selecting button

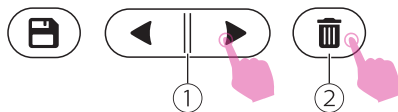
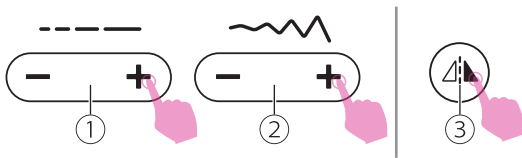
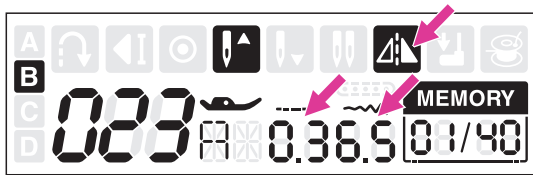
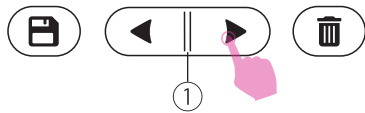
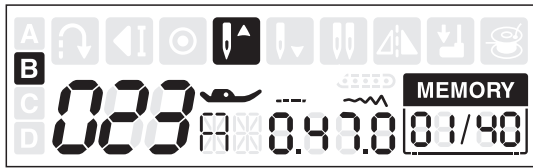

❖ Editing stitches

Use the memory stitch selecting button "left" or "right" to select the stitch to edit.

- ① Memory stitch selecting button

The stitch length, stitch width and mirror of the stitches can be adjusted manually.

- ① Stitch length adjustment button
- ② Stitch width adjustment button
- ③ Mirror button

❖ Clearing stitches

Use the memory stitch selecting button "left" or "right" to select the stitch that you want to clear.

Press the clear button to delete the selected stitch and the next stitch in the back will move forward.

- ① Memory stitch selecting button
- ② Clear button

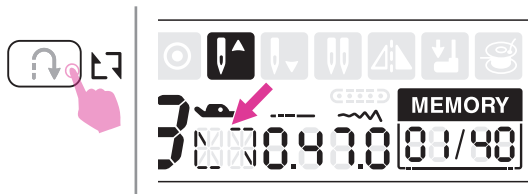

❖ Repeat setting

Under the memory mode, the reverse button is using for repeat sewing. The stitch combination can be sewn continuously if the icon appeared.

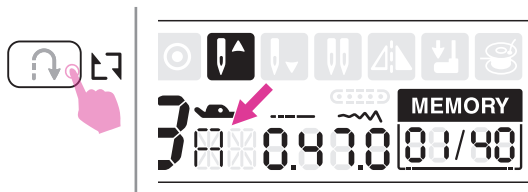

Press the reverse button again to cancel repeat sewing function, the icon will be disappeared on LCD screen.

Note

The repeat sewing function setting returns to off as its default setting while leave the memory mode.

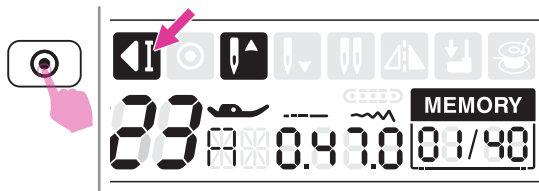

During machine is sewing, the machine will sew 3 locking stitches at the end of the current stitch if the auto-lock button pressed. Then it will stop automatically. The LCD screen will display the auto-lock icon. If pressing the start/stop button again, it will sew from the next stitch.



Stitch Chart



Stitch chart

❖ A-Direct Pattern Group **A**

Stitch Pattern			Width(mm)		Length(mm)		Presser Foot	Fuctions			
			Auto	Manual	Auto	Manual					
Direct	1		3.5	0.0~7.0	2.5	0.0~4.5	T	*	*	*	*
	2		0.0	0.0~7.0	2.5	0.0~4.5	T	*	*	*	*
	3		3.5	0.0~7.0	2.5	1.0~3.0	T	*	*	*	*
	4		3.5	1.0~6.0	2.5	1.0~3.0	T	*	*	*	*
	5		5.0	0.0~7.0	2.0	0.3~1.0 1.0~4.5	T	*	*	*	*
	6		5.0	2.0~7.0	1.0	0.3~1.0 1.0~4.5	T	*	*	*	*
	7		5.0	2.5~7.0	2.5	1.0~3.0	T	*	*	*	*
	8		5.0	3.5~7.0	2.5	1.0~3.0	T	*	*	*	*
	9		3.5	1.0~7.0	2.0	0.5~4.5	T	*	*	*	*
	0		5.0	3.0~7.0	0.4	0.3~1.0	D				

❖ B-Regular Pattern Groups **B**

Stitch Pattern			Width(mm)		Length(mm)		Presser Foot	Fuctions			
			Auto	Manual	Auto	Manual					
Utility	000		3.5	0.0~7.0	2.5	1.5~3.0	T	*	*	*	*
	001		3.5	2.5~7.0	1.0	0.5~4.5	T	*	*	*	*
	002		5.0	2.5~7.0	2.5	1.0~3.0	T	*	*	*	*
	003		5.0	2.5~7.0	2.5	1.0~3.0	T	*	*	*	*
	004		7.0	2.5~7.0	2.5	1.0~3.0	A	*	*	*	*
	005		5.0	2.5~7.0	2.5	1.0~3.0	A	*	*	*	*
	006		7.0	2.5~7.0	2.5	1.5~3.0	T	*	*	*	*
Buttonhole	007		7.0	2.5~7.0	1.5	1.0~3.0	T	*	*	*	*
	008		5.0	3.0~5.5	0.4	0.3~1.0	D				
	009		5.0	3.0~5.5	0.4	0.3~1.0	D				
	010		5.0	3.0~5.5	0.4	0.3~1.0	D				
	011		5.0	3.0~5.5	0.4	0.3~1.0	D				
	012		7.0	5.5~7.0	0.4	0.3~1.0	D				
	013		7.0	5.5~7.0	0.4	0.3~1.0	D				
	014		7.0	5.5~7.0	0.4	0.3~1.0	D				
Darning	015		6.0	3.0~7.0	1.0	1.0~2.0	D				
Bar tack	016		6.0	3.0~7.0	1.5	1.0~3.0	D				
Darning	017		7.0	3.5~7.0	2.0	1.0~2.0	D				
Bar tack	018		2.0	1.0~3.0	0.5	0.5~1.0	D				
Eyelet	019		7.0	5.0 6.0 7.0	—	—	A				
Button sewing	020		3.5	2.5~4.5	—	—	H				
Satin	021		7.0	2.5~7.0	0.4	0.3~1.0	A	*	*	*	*
	022		7.0	2.5~7.0	0.4	0.3~1.0	A	*	*	*	*
	023		7.0	2.5~7.0	0.4	0.3~1.0	A	*	*	*	*
	024		7.0	2.5~7.0	0.4	0.3~1.0	A	*	*	*	*
	025		7.0	2.5~7.0	0.4	0.3~1.0	A	*	*	*	*
	026		7.0	2.5~7.0	0.4	0.3~1.0	A	*	*	*	*
	027		7.0	2.5~7.0	0.4	0.3~1.0	A	*	*	*	*
	028		7.0	2.5~7.0	0.4	0.3~1.0	A	*	*	*	*
	029		7.0	2.5~7.0	0.4	0.3~1.0	A	*	*	*	*
	030		7.0	2.5~7.0	0.4	0.3~1.0	A	*	*	*	*
	031		7.0	2.5~7.0	0.4	0.3~1.0	A	*	*	*	*
	032		7.0	2.5~7.0	0.4	0.3~1.0	A	*	*	*	*
	033		7.0	2.5~7.0	0.4	0.3~1.0	A	*	*	*	*

Stitch Pattern		Width(mm)		Length(mm)		Presser Foot	Fuctions				
		Auto	Manual	Auto	Manual						
Satin	034		7.0	2.5~7.0	0.4	0.3~1.0	A	*	*	*	*
	035		7.0	2.5~7.0	0.4	0.3~1.0	A	*	*	*	*
	036		7.0	2.5~7.0	0.4	0.3~1.0	A	*	*	*	*
	037		7.0	3.0~7.0	0.4	0.3~1.0	A	*	*	*	*
	038		7.0	2.5~7.0	0.4	0.3~1.0	A	*	*	*	*
	039		7.0	2.5~7.0	0.4	0.3~1.0	A	*	*	*	*
Cross	040		5.0	2.5~7.0	2.5	1.0~3.0	A	*	*	*	*
	041		4.0	3.0~7.0	1.0	1.0~3.0	A	*	*	*	*
	042		6.0	3.0~7.0	1.0	1.0~3.0	A	*	*	*	*
	043		6.0	3.0~7.0	1.0	1.0~3.0	A	*	*	*	*
Quilt	044		3.5	2.5~7.0	2.5	1.5~3.0	T	*	*	*	*
	045		3.5	2.5~7.0	2.5	1.5~3.0	T	*	*	*	*
	046		3.5	2.5~7.0	2.5	1.5~3.0	T	*	*	*	*
	047		4.0	2.5~7.0	2.0	1.5~3.0	T	*	*	*	*
	048		7.0	3.0~7.0	1.5	1.5~3.0	T	*	*	*	*
	049		5.0	2.5~7.0	2.0	1.0~3.0	A	*	*	*	*
	050		6.0	3.0~7.0	2.0	1.0~3.0	T	*	*	*	*
	051		5.0	2.5~7.0	2.0	1.0~3.0	A	*	*	*	*
	052		2.0	1.5~7.0	3.0	1.5~3.0	A	*	*	*	*
	053		6.0	3.0~7.0	2.0	1.0~3.0	T	*	*	*	*
054		5.0	3.0~7.0	2.0	1.0~3.0	T	*	*	*	*	
Decorative	055		5.0	3.0~7.0	3.0	1.5~3.0	A	*	*	*	*
	056		7.0	2.5~7.0	2.0	1.0~3.0	T	*	*	*	*
	057		7.0	2.5~7.0	2.5	1.5~3.0	T	*	*	*	*
	058		5.0	2.5~7.0	2.5	1.5~3.0	T	*	*	*	*
	059		7.0	2.5~7.0	1.5	1.0~3.0	A	*	*	*	*
	060		5.0	4.0~7.0	2.5	1.5~3.0	A	*	*	*	*
	061		5.0	2.5~7.0	2.5	1.0~3.0	A	*	*	*	*
	062		7.0	3.5~7.0	2.0	1.0~3.0	T	*	*	*	*
	063		7.0	3.5~7.0	1.0	1.0~3.0	A	*	*	*	*
	064		5.0	2.5~7.0	1.0	1.0~4.5	T	*	*	*	*
	065		7.0	3.0~7.0	2.0	1.5~3.0	A	*	*	*	*
	066		5.0	2.5~7.0	2.0	2.0~3.0	A	*	*	*	*
	067		7.0	3.0~7.0	2.5	1.0~3.0	T	*	*	*	*
	068		7.0	2.5~7.0	2.0	1.5~3.0	T	*	*	*	*
	069		7.0	3.0~7.0	3.0	1.0~3.0	A	*	*	*	*
	070		7.0	2.5~7.0	3.0	2.0~3.0	A	*	*	*	*
	071		7.0	3.0~7.0	2.0	1.5~3.0	A	*	*	*	*
	072		7.0	2.5~7.0	2.0	1.0~3.0	A	*	*	*	*
	073		5.0	3.5~7.0	1.0	1.0~3.0	A	*	*	*	*
	074		7.0	3.0~7.0	2.5	1.5~3.0	T	*	*	*	*
	075		7.0	3.5~7.0	2.5	1.5~3.0	T	*	*	*	*
	076		7.0	2.5~7.0	3.0	1.0~3.0	T	*	*	*	*
	077		7.0	2.5~7.0	3.0	1.0~3.0	T	*	*	*	*
	078		6.0	2.5~7.0	3.0	1.0~3.0	T	*	*	*	*
	079		5.0	2.5~7.0	2.0	1.0~3.0	T	*	*	*	*
	080		5.0	3.0~7.0	1.5	1.5~3.0	T	*	*	*	*
	081		5.0	3.0~7.0	2.0	2.0~3.0	A	*	*	*	*
	082		7.0	2.5~7.0	1.5	1.5~3.0	A	*	*	*	*
	083		7.0	4.0~7.0	3.0	2.0~3.0	A	*	*	*	*
	084		5.0	4.0~7.0	1.5	1.0~3.0	A	*	*	*	*

Stitch Pattern		Width(mm)		Length(mm)		Presser Foot	Fuctions				
		Auto	Manual	Auto	Manual						
Decorative	085		7.0	3.0~7.0	3.0	2.0~3.0	A	*	*	*	*
	086		5.0	3.0~7.0	1.5	1.0~3.0	T	*	*	*	*
	087		5.0	2.5~7.0	2.0	1.0~4.5	T	*	*	*	*
	088		5.0	2.5~7.0	2.0	1.0~3.0	T	*	*	*	*
	089		5.0	2.5~7.0	2.5	1.5~3.0	T	*	*	*	*
	090		6.0	3.5~7.0	2.0	1.5~3.0	A	*	*		*
	091		7.0	2.5~7.0	2.5	1.5~3.0	A	*	*	*	*
	092		7.0	2.5~7.0	2.0	1.5~3.0	T	*	*	*	*
	093		7.0	3.5~7.0	1.5	1.5~3.0	T	*	*		*
	094		5.0	2.5~7.0	1.5	1.0~3.0	T	*	*	*	*
	095		7.0	3.0~7.0	2.0	1.5~3.0	A	*	*	*	*
	096		7.0	5.0~7.0	2.0	2.0~3.0	A	*	*		*
	097		7.0	4.0~7.0	2.5	1.5~3.0	A	*	*		*
	098		5.0	2.5~7.0	1.5	1.0~3.0	T	*	*	*	*
	099		7.0	1.0~7.0	2.0	1.0~4.0	T	*	*	*	*
	100		7.0	4.0~7.0	3.0	2.0~3.0	A	*	*		*
	101		7.0	3.5~7.0	3.0	1.5~3.0	A	*	*		*
	102		7.0	4.0~7.0	2.0	1.5~2.5	A	*	*		*
	103		6.0	2.5~7.0	1.0	1.0~3.0	T	*	*	*	*
	104		7.0	3.5~7.0	2.5	1.5~3.0	A	*	*		*
105		7.0	3.5~7.0	2.5	2.0~3.0	A	*	*		*	

❖ C-Alphabet Group-Block style **C**

000 001 002 003 004 005 006 007 008 009
0 1 2 3 4 5 6 7 8 9
010 011 012 013 014 015 016 017 018 019 020 021 022 023 024 025 026 027 028 029 030 031 032
A B C D E F G H I J K L M N O P Q R S T U V W
033 034 035 036 037 038 039 040 041 042 043 044 045 046 047 048 049 050 051 052 053 054 055
X Y Z a b c d e f g h i j k l m n o p q r s t
056 057 058 059 060 061 062 063 064 065 066 067 068 069 070 071 072 073 074 075 076 077 078
u v w x y z Ä Å Æ Ñ Ö Ø Ç Ü ä å æ ë è é ê ñ
079 080 081 082 083 084 085 086 087 088 089 090 091 092 093 094 095 096 097 098 099
ö õ ø ì ç ü ù ß & ? ! _ ' , . - () @ + =

❖ D-Alphabet Group-Script style **D**

000 001 002 003 004 005 006 007 008 009
0 1 2 3 4 5 6 7 8 9
010 011 012 013 014 015 016 017 018 019 020 021 022 023 024 025 026 027 028 029 030 031 032
A B C D E F G H I J K L M N O P Q R S T U V W
033 034 035 036 037 038 039 040 041 042 043 044 045 046 047 048 049 050 051 052 053 054 055
X Y Z a b c d e f g h i j k l m n o p q r s t
056 057 058 059 060 061 062 063 064 065 066 067 068 069 070 071 072 073 074 075 076 077 078
u v w x y z Ä Å Æ Ñ Ö Ø Ç Ü ä å æ ë è é ê ñ
079 080 081 082 083 084 085 086 087 088 089 090 091 092 093 094 095 096 097 098 099
ö õ ø ì ç ü ù ß & ? ! _ ' , . - () @ + =



| Sewing Basics



Straight stitch

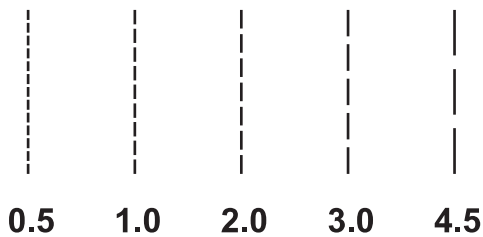
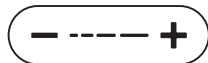
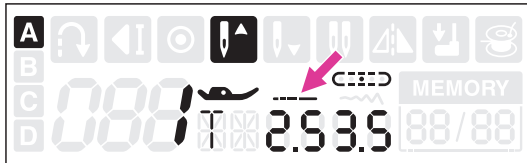
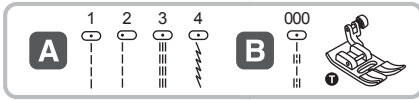

Using the all purpose foot.

Set the stitch as shown in figure.

The stitch length can be regulated by pressing the stitch length adjustment button.

For a shorter stitch, press the "-" button. For a longer stitch, press the "+" button.

Generally speaking, the thicker the fabric, thread and needle, the longer the stitch length should be.

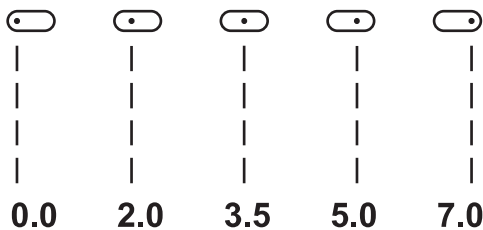

❖ Changing the needle position

The needle position for straight stitches can be changed by adjusting the stitch width adjustment button.

The pre-set position is "3.5", center position.

Press the stitch width adjustment button "+", the needle position will be moved to the right.

Press the stitch width adjustment button "-", the needle position will be moved to the left.

Zigzag stitch

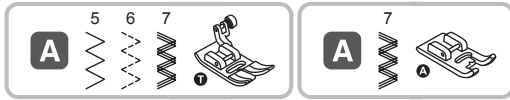

Using the all purpose foot or satin stitch foot.



Set the stitch as shown in figure.

The width can be adjusted between "0.0-7.0" as you press the stitch width adjustment button "+" or "-".

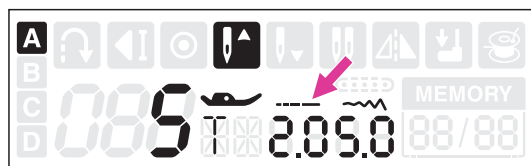
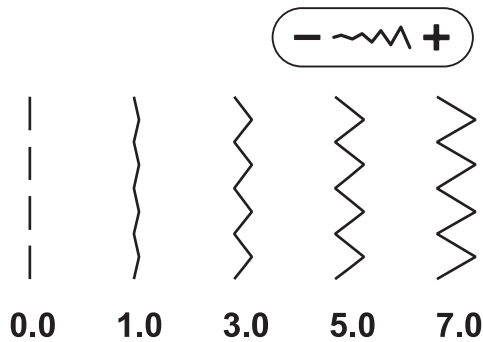

Press the stitch length adjustment button "+" or "-" to adjust the stitch length. Neat zigzag stitches are usually achieved at "2.5" or below.

Closed up zigzag stitches are referred to as a satin stitch.

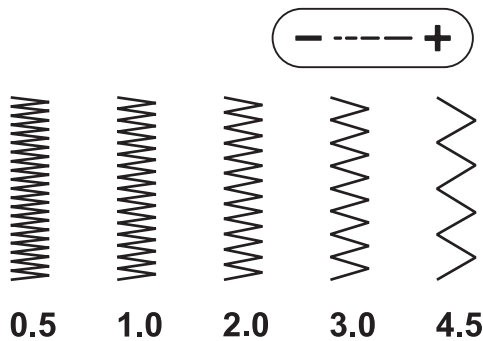

Starting to sew

Make sure you follow the needle/fabric/thread combinations and use the suggested presser foot before sewing.

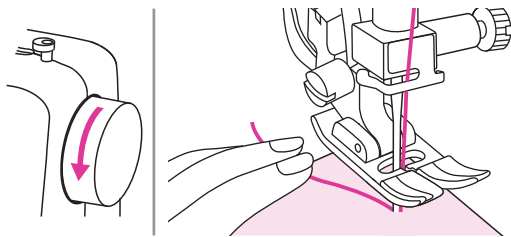
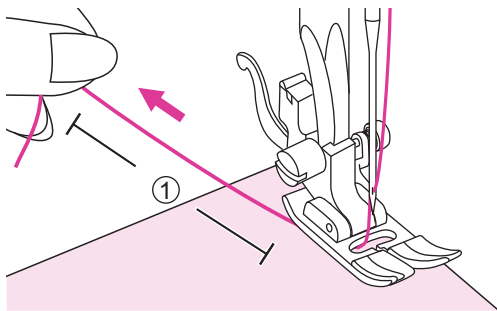
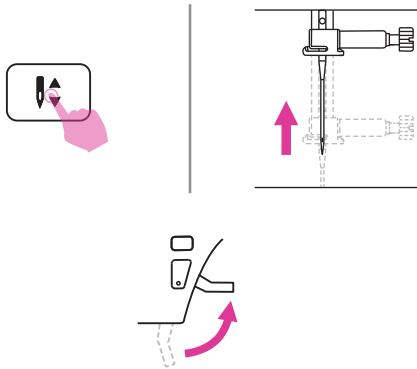
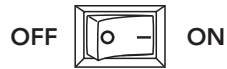

1. Turn the power switch to on ("I").
2. Press the needle up/down position button to bring the needle to highest position.
3. Raise the presser foot lifter. Select a stitch.
4. Place the fabric under the presser foot, pass the thread under the presser foot, and then pull out about 10cm of thread toward the rear of the machine.
① 10cm
5. Turn the handwheel toward you (counter-clockwise) to lower the needle into the fabric at the beginning of the stitching.
6. Lower the presser foot lifter.

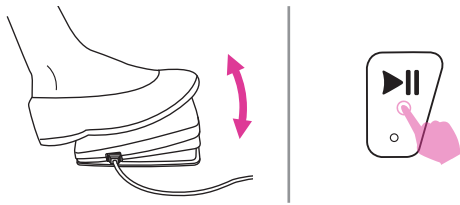

7. Slowly press down the foot control or long press the start/stop button to start sewing. Release the foot control or press the start/stop button again to stop the machine.

Note

You can use reverse sewing for back tacking and reinforcing seams by pressing the reverse button. Please refer to "Useful skills" chapter for more information.

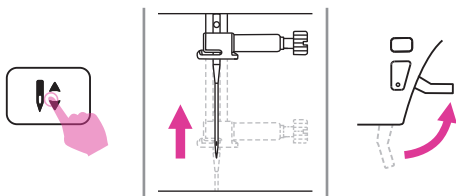

8. Press the needle up/down position button to raise the needle. Raise the presser foot lifter and remove the fabric.

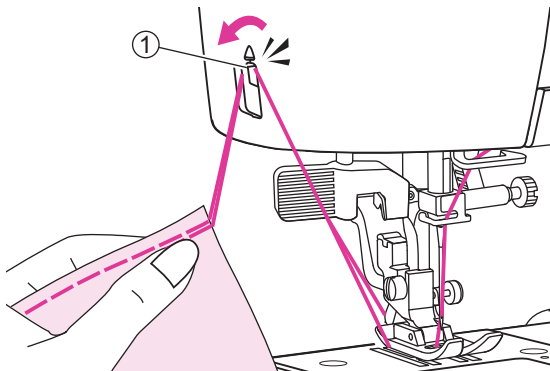

9. Guide both threads to the side of the face plate and into the thread cutter to cut them.

① Thread cutter

Useful skills

Various ways to achieve better results for your sewing projects are described below. Refer to these tips when sewing your project.

The results depend on types of fabrics and stitches. Please use the same fabric of the project and do a sewing test in advance.

For the trial sewing, use a piece of fabric and thread that are same as those used for your project and check the thread tension and stitch length and width.

Since the results differ depending on types of stitching and layers of fabric sewn, perform the trial sewing under the same conditions that will be used with your project.

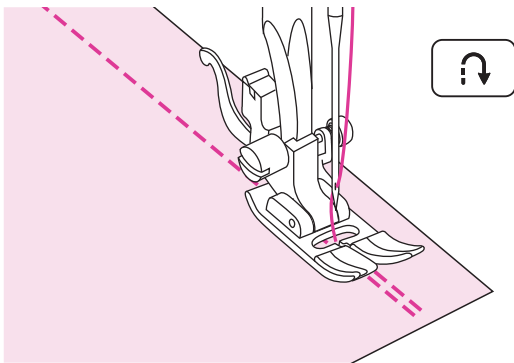

❖ Reverse sewing

Reverse stitching is used to secure the threads at the beginning and at the end of a seam.

Press the reverse button and sew 4-5 stitches.

The machine will sew forward when the button is released.

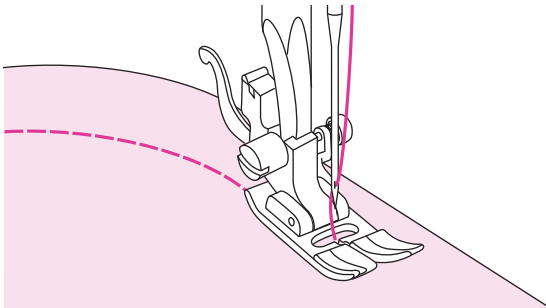

❖ Sewing curves

Slightly change the sewing direction to sew around the curve.

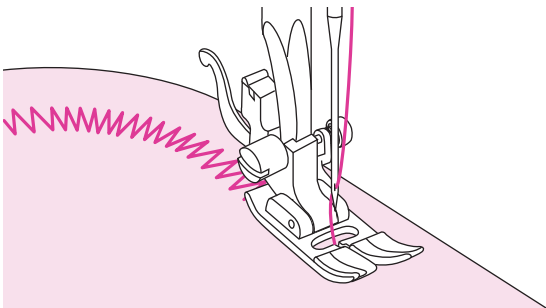

When sewing along a curve while using a zigzag stitch, select a shorter stitch length in order to obtain a finer stitch.

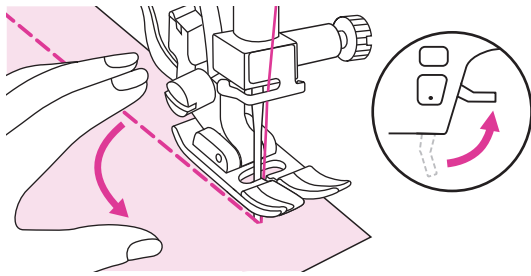

❖ Sewing corners

Stop the sewing machine when you reach a corner.

Lower the needle into the fabric. Raise the presser foot lifter. Use the needle as a pivot and turn the fabric 90°.

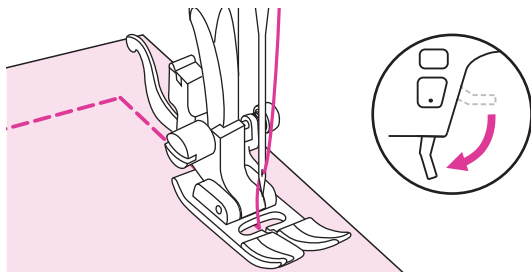

Lower the presser foot lifter and resume sewing.

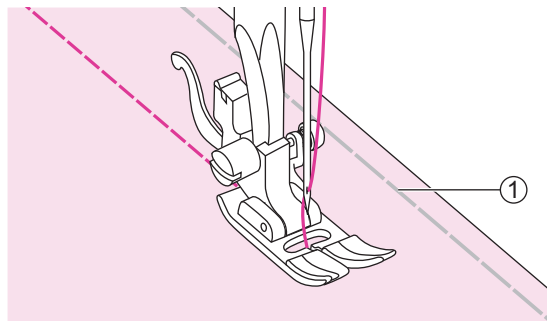

❖ Sewing stretch fabrics

Baste the pieces of fabric together, and then sew without stretching the fabric.

- ① Basting

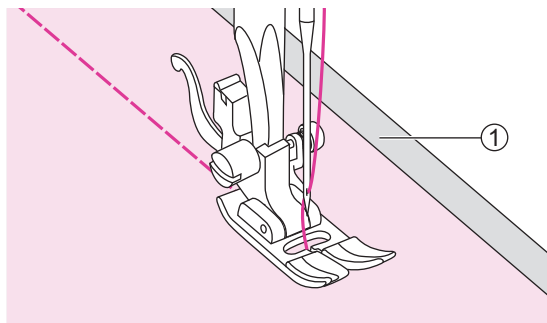

❖ Sewing thin fabrics

When sewing thin fabrics, the stitches may become misaligned or the fabric may not feed correctly. If this occurs, place thin paper or stabilizer material under the fabric and sew it together with the fabric.

When you have finished sewing, tear off any excess paper.

- ① Stabilizer material or paper

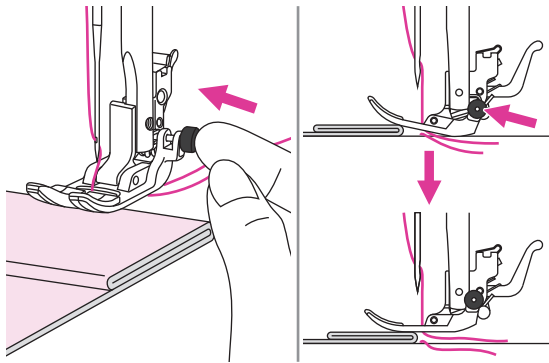

❖ Sewing heavy fabric

The black button on the right side of the presser foot will lock the presser foot in a horizontal position if you push it in before lowering the presser foot.

This ensures even feeding at the beginning of a seam and helps when sewing multiple layers of fabrics such as sewing over seams when hemming jeans.

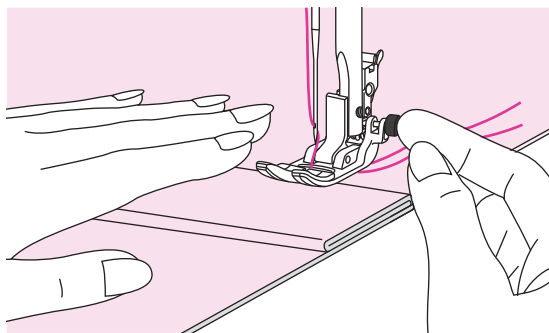

When you reach the point of an increased thickness, lower the needle and raise the presser foot lifter. Press the toe of the foot to the horizontal line and push in the black button, then lower the foot and continue sewing.

The black button releases automatically after sewing few stitches.

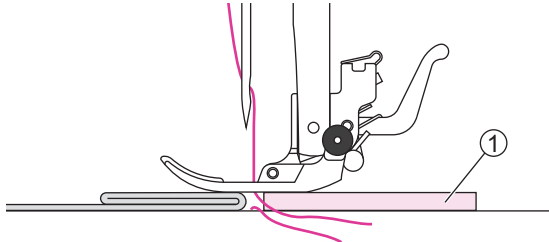

You also can place another piece of fabric with the same thickness at the back of the seam. Or support the presser foot while feeding by hand and sewing toward the folded side.

① Cardboard or thick fabric



Utility Stitches



Stretch stitch

Use this stitch with knitted tricot or other stretchy fabrics. The stitch enables your seam to stretch without breaking the thread.

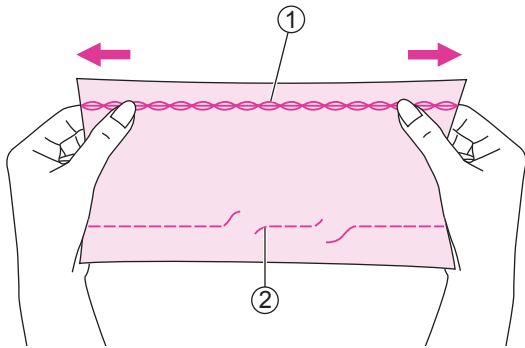

Good for easy to ravel and knit fabrics. It's good for joining durable fabric such as denims.

These stitches can also be used as a decorative top stitches.

- ① Stretch stitch
- ② Straight stitch

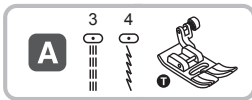

Using the all purpose foot.

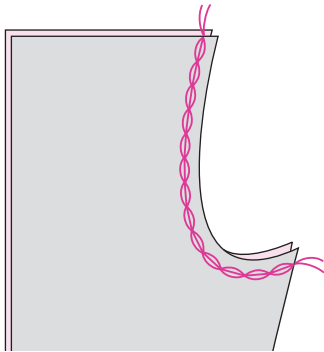

❖ Straight stretch stitch

Straight stretch stitch is used to add triple reinforcement to stretch and hardwearing seams.

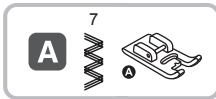

Using the satin stitch foot.

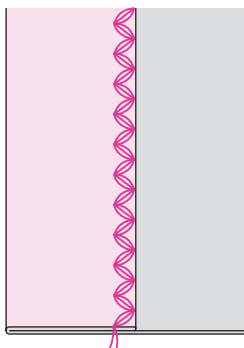

❖ Zigzag stretch stitch

Triple zigzag stretch stitch is suitable for firm fabrics like denim, poplin, etc.

Sewing stretch fabrics and elastic tape

When elastic tape is attached to the cuff or waist of a piece of clothing, the finished dimensions will be that of the stretched elastic tape. Therefore, it is necessary that a suitable length of the elastic tape be used.



Using the all purpose foot.

Pin the elastic tape to the wrong side of fabric at a few points to make sure that the tape is uniformly positioned on the fabric.

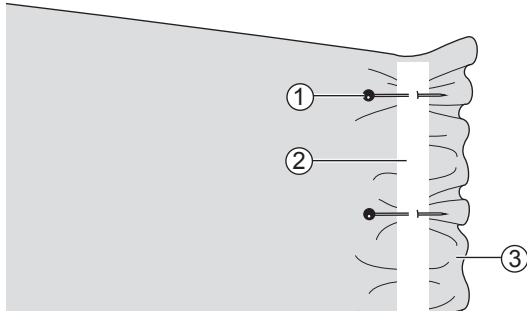

- ① Pin
- ② Elastic tape
- ③ Wrong side

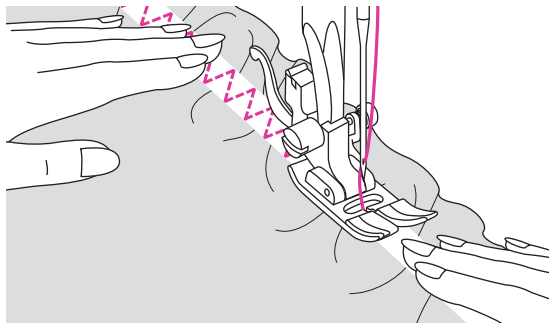

Sew the elastic tape to the fabric while stretching the tape so that it is the same length as the fabric.

While pulling the fabric behind the presser foot with your left hand, pull the fabric at the pin nearest the front of the presser foot with your right hand.

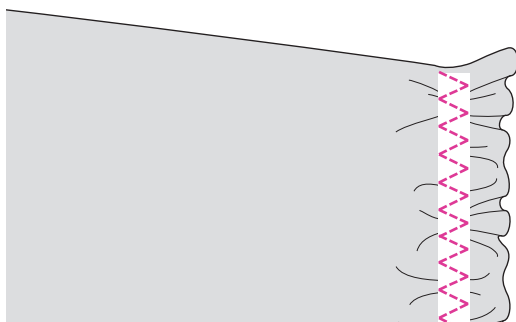

Note

When sewing, be sure that the needle does not touch any pins, otherwise the needle may bend or break.

Overcasting stitch

Sewing overcasting stitches along the edge of fabric to prevent it from fraying.

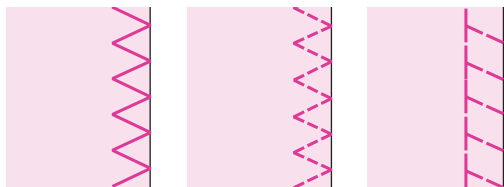
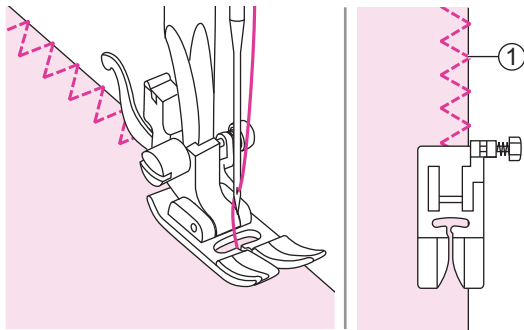

❖ Using the all purpose foot

Attach the all purpose foot.

Sew the overcasting along the edge of the fabric so that the needle drops over the edge of the fabric on the right side.

- ① Needle drop point

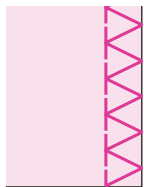
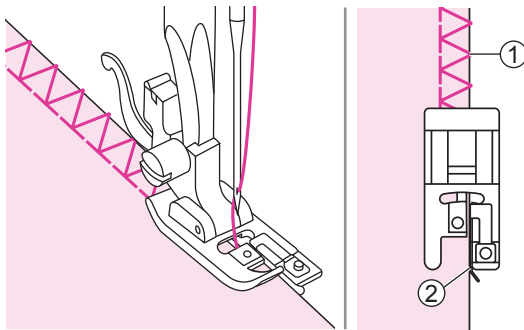

❖ Using the overcasting foot

Attach the overcasting foot.

Sew the fabric with the fabric edge against the guide of the overcasting foot.

- ① Needle drop point
- ② Guide

Blind Hem

Secure the bottom of skirts and pants with a blind hem, this stitch will sew with invisible stitch on the right side of the fabric.

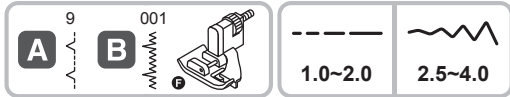

Using the blind hem foot.

9: Blind hem/lingerie for firm fabrics.

001: Blind hem for stretch fabrics.

Note

Please use the same fabric of the project and do a sewing test in advance.

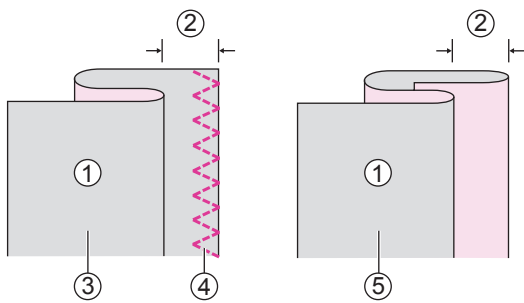

Fold the fabric as illustrated with the wrong side up.

- ① Wrong side
- ② 5mm
- ③ For heavy weight fabric
- ④ Overcasting stitch
- ⑤ For light/medium weight fabric

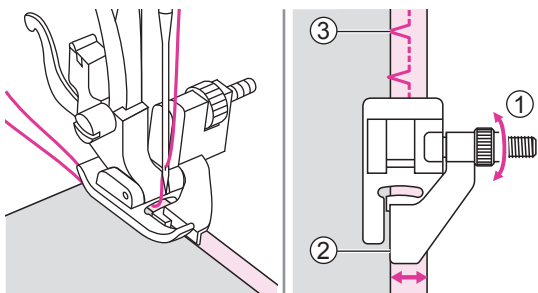

Place the fabric under the foot. Turn the handwheel forwards until the needle swings fully to the left. It should just pierce the fold of the fabric. If it does not, adjust the stitch width accordingly. Adjust the guide by turning the knob so that the guide just rests against the fold.

- ① Knob
- ② Guide
- ③ Needle drop point

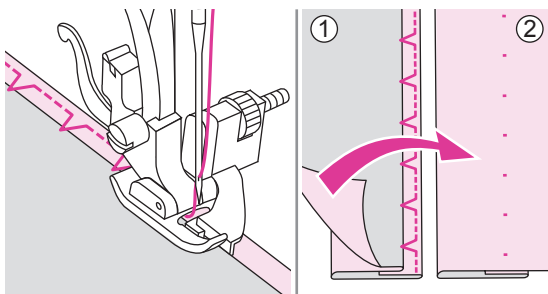

Sew slowly, guiding the fabric carefully along the edge of the guide.

Turn over the fabric.

- ① Wrong side
- ② Right side

Buttonhole stitch

Buttonholes can be adapted to the size of the button.

For stretch fabric or thin fabric, it is recommended to use a stabilizer for a better buttonhole sewing. Slightly reduce upper thread tension to produce better results.

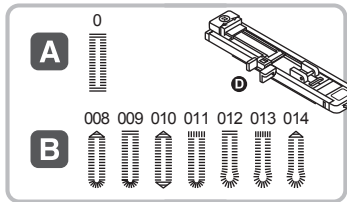

Using the buttonhole foot.

0/009: For thin or medium fabric

012/013: For suits or overcoats

011: **Heavy-duty buttonholes with vertical bar tacks**

008/010: Reinforced waist tapered buttonhole

014: For jeans or trousers

Note

Please use the same fabric of the project and do a sewing test in advance.

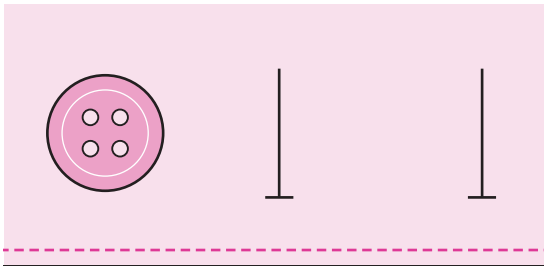

Mark the positions of the buttonhole on the fabric.

The maximum buttonhole length is 3cm. (Total of diameter + thickness of button.)

The size of the buttonhole is determined by the button inserted in the button plate.

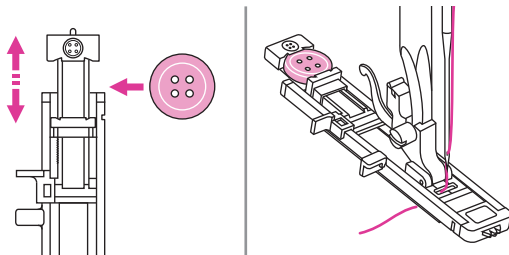

Pull the button holder plate to the back, and place the button in it. Push back the button holder plate against the button to hold it tight.

Attach the buttonhole foot.

The thread should be passed through the hole in the presser foot, then be placed under the foot.

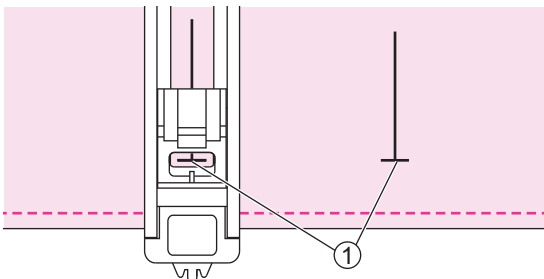

Position the fabric under the presser foot so that the centerline's mark is aligning with the center of the buttonhole foot.

① Starting point

Select the buttonhole stitch. Adjust the stitch width and the stitch length to the desired width and density.

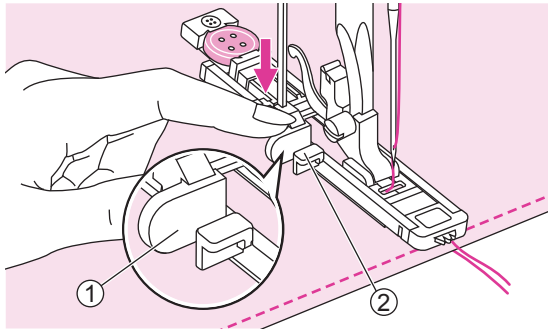

Pull the buttonhole lever all the way down and position it behind the bracket on the buttonhole foot.

- ① Buttonhole lever
- ② Bracket

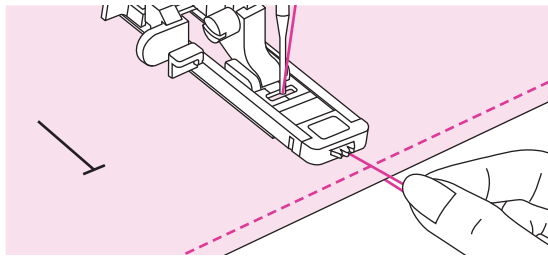

Slightly hold the end of the upper thread and start sewing. Pull two lines together.

Note

Gently feed the fabric by hand.

Before stopping, the machine will automatically sew a reinforcement stitch after the buttonhole is sewn.

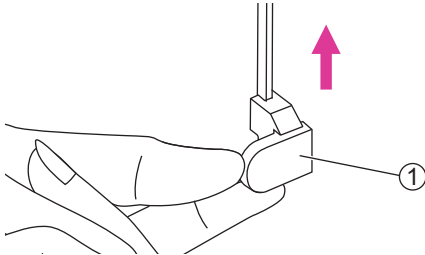

Raise the presser foot lifter and cut the thread. To sew over the same buttonhole, raise the presser foot lifter (it will return to its original position).

After sewing the buttonhole stitch, raise the buttonhole lever as far as it will go.

- ① Buttonhole lever

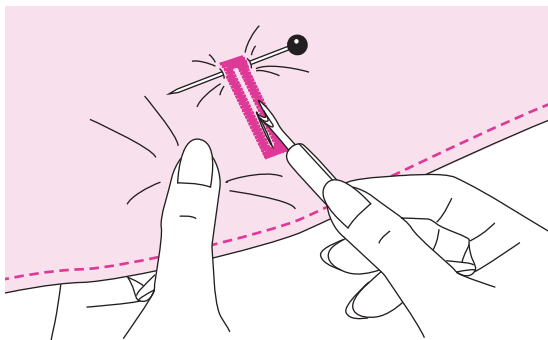

Use the seam ripper to cut the center of the buttonhole being careful not to cut any stitches on either side. Use a pin as a stopper at the bar tack so you do not cut too much.

Note

When cutting the buttonhole with the seam ripper, do not place your hands in the cutting direction, otherwise injuries may result.

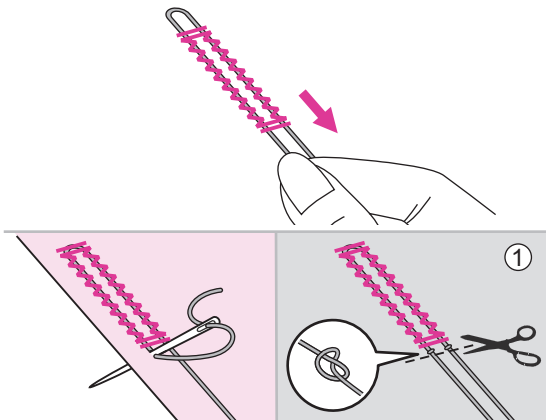
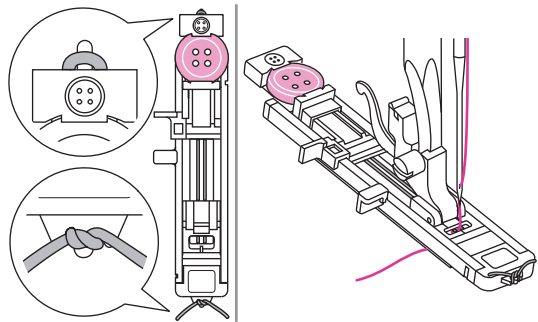
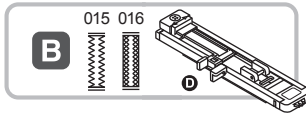

❖ Making a buttonhole on stretch fabrics

015: For stretch or woven fabric

016: For stretch fabric

When sewing buttonholes on stretch fabric, hook heavy thread or cord under the buttonhole foot.

Attach the buttonhole foot. Bring the gimp thread ends to the front of the foot and insert them into the grooves, then tie them there temporarily. Lower the presser foot lifter and start sewing.

Set the stitch width to match the diameter of the gimp thread.

Once sewing is completed, pull the gimp thread gently to remove any slack. Cross the gimp in front of the needle and thread gimp ends into a large needle, pull to the wrong side and knot ends before cutting excess.

① Wrong side

Note

It is suggested that you sew with a stabiliser material under the fabric.

* Buttonholes are sewn from the front of the presser foot to the back, as shown.

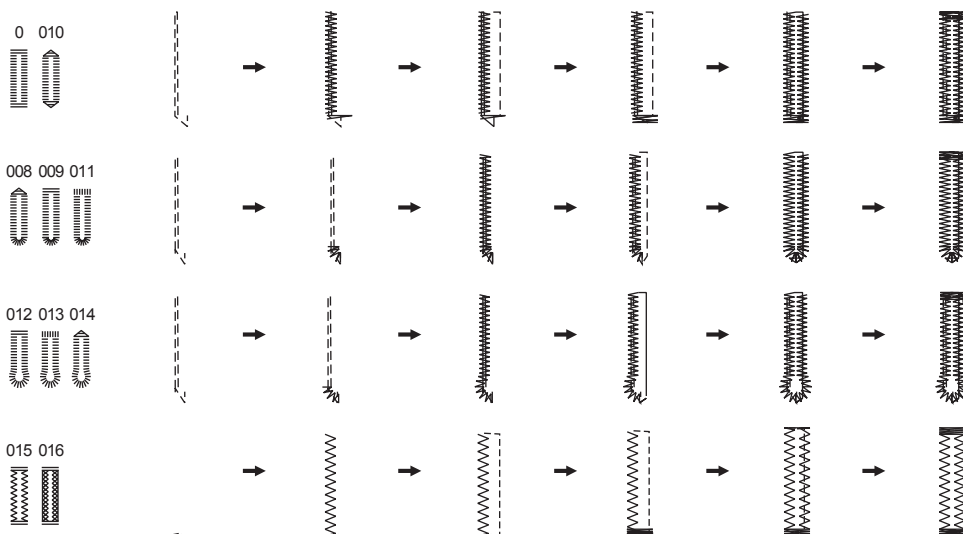

Bar tack stitch

Bar tack stitch is used to reinforce points subject to strain, such as pocket corners and openings.

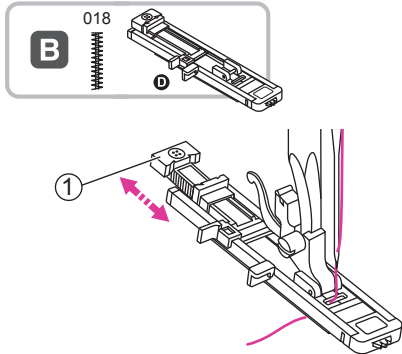

Using the buttonhole foot.

Extend the button holder plate and set to the desired length. Adjust the stitch width and the stitch length to the desired width and density.

Attach the buttonhole foot. The thread should be passed through the hole in the presser foot, then be placed under the foot.

- ① Button holder plate

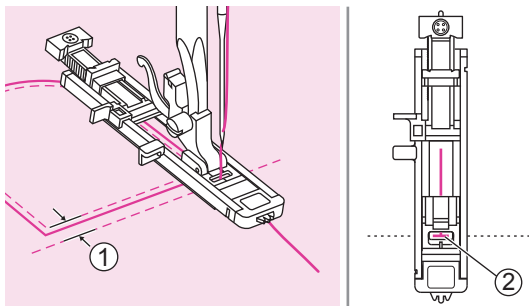

Position the fabric so that the needle is 2mm in front of where you want the sewing to start, and then lower the presser foot lifter.

- ① 2mm
- ② Starting point

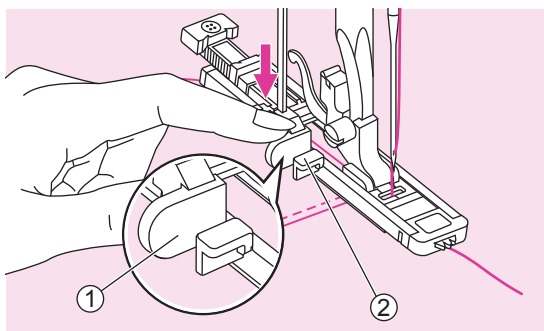

Pull the buttonhole lever all the way down and position it behind the bracket on the buttonhole foot.

Slightly hold the end of the upper thread and start sewing.

- ① Buttonhole lever
- ② Bracket

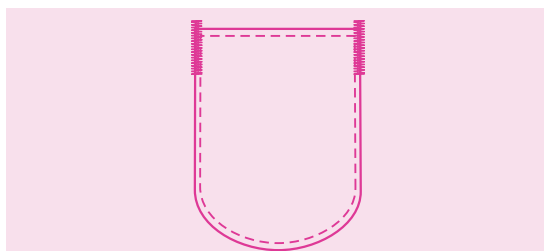

Bar tack stitches are sewn.

Note

It is suggested that you sew with a stabilizer material under the fabric.

Darning stitch

Darning a small hole or a tear before it becomes larger can save a garment. Choose a fine thread in a color as close to your garment possible.

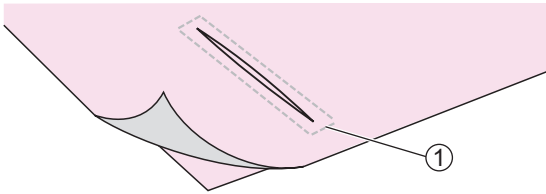
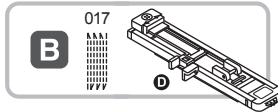

Using the buttonhole foot.

Baste the upper fabric and the under fabric together.

① Basting

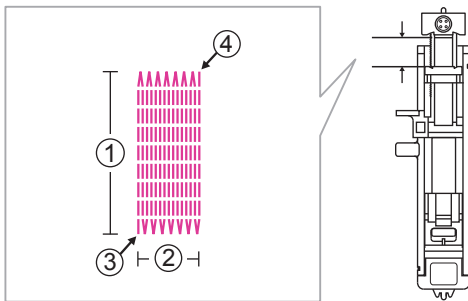

The size of one darn cycle is variable.

However, the maximum stitch length is 2.6cm and the maximum stitch width is 7mm.

- ① The length of sewing
- ② The width of sewing
- ③ Star
- ④ Stop

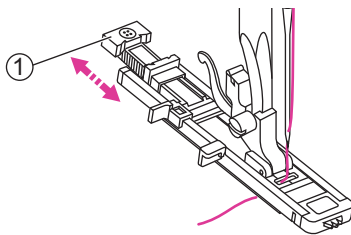

Extend the button holder plate and set to the desired length. Adjust the stitch width and the stitch length to the desired width and density.

Attach the buttonhole foot. The thread should be passed through the hole in the presser foot, then be placed under the foot.

① Button holder plate

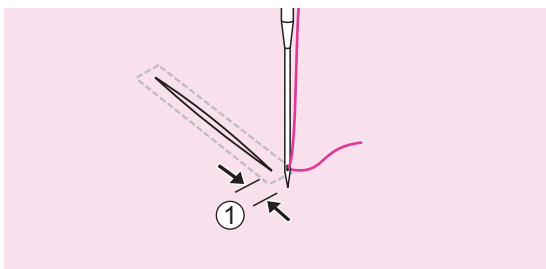

Position the fabric so that the needle is 2mm in front of the area to be darned, and then lower the presser foot lifter.

① 2mm

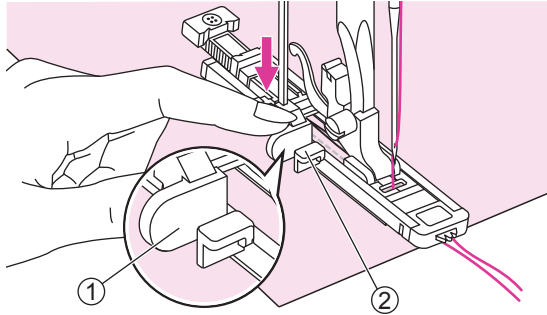

Pull the buttonhole lever all the way down and position it behind the bracket on the buttonhole foot.

Slightly hold the end of the upper thread and start sewing.

- ① Buttonhole lever
- ② Bracket



Darning stitches are sewn from the front of the presser foot to the back, as shown.

Note

If the fabric does not feed, for example, because it is too thick, increase the stitch length.

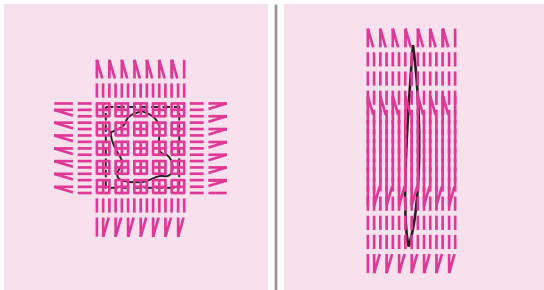

If the sewing range is too big to sew, then we suggest you can sew several times (or cross sew) to get better sewing result.

Eyelet stitch

Eyelet stitches are used for making belt holes and other similar applications.

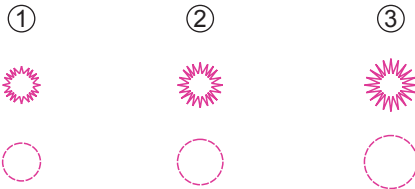
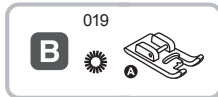

Using the satin stitch foot.

Press the "+" or "-" stitch width adjustment button to select the eyelet size.

- ① Small: 5.0mm
- ② Medium: 6.0mm
- ③ Large: 7.0mm

Lower the needle into the fabric at the beginning of the stitching, and then lower the presser foot lifter.

Once sewing is completed, the machine automatically sews reinforcement stitches, then stops.

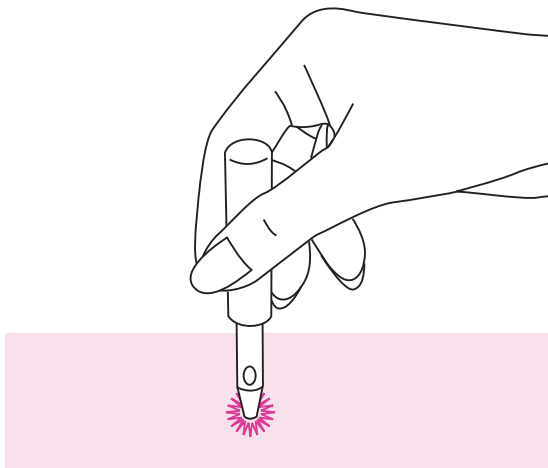

Make a hole at the center using an eyelet punch.

* Eyelet punch is not included with the machine.

Note

When using the eyelet punch, place thick paper or some other protective sheet under the fabric before punching the hole in the fabric.

If thin thread is used, the stitching may be coarse. If this occurs, sew the eyelet twice one on top of the other.

Button sewing

Buttons can be sewn on with the sewing machine. Buttons with 2 or 4 holes can be attached.

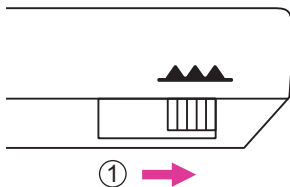
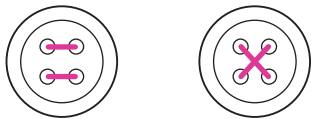
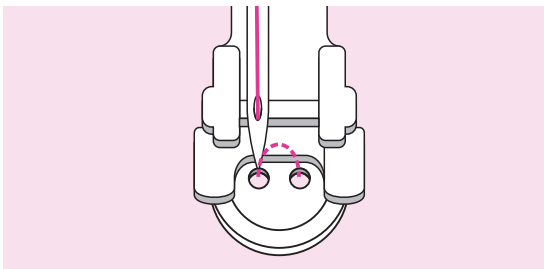
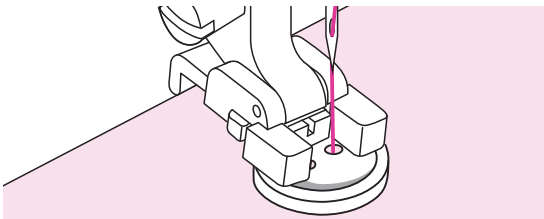
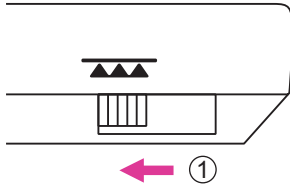
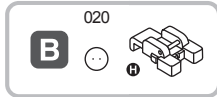

Using the button sewing foot.

Move the drop feed lever to lower the feed dogs.

① Lowered position

Put the work under the foot and place the button in desired position, then lower the foot.

Select the buttonhole sewing stitch and adjust the stitch width according to the distance between the two holes of the button.

Turn the handwheel to check that the needle goes cleanly into the left and right holes of the button.

For buttons with 4 holes, sew through the front two holes first, push work forward and then sew through the back two holes.

When you finish the work, move the drop feed lever to raise the feed dogs.

① Raised position

Zipper insertion

This foot can be set to sew on each side of the zipper, the edge of the foot guides the zipper to ensure straight placement.



Using the zipper foot.

⚠ Attention

Zipper foot should be used for sewing straight stitches only. It is possible that the needle could hit the presser foot and break when sewing other stitches.

When sewing, be sure that the needle does not touch the zipper, otherwise the needle may bend or break.

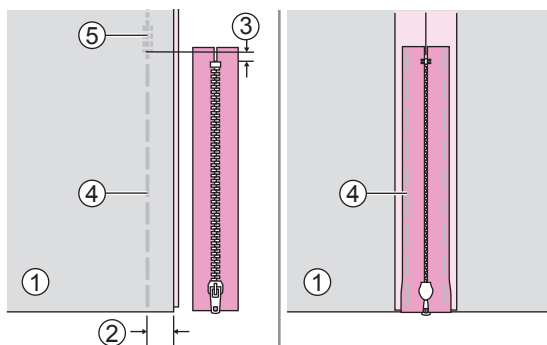

❖ Inserting a centered zipper

Place the right sides of the fabric together. Sew a bottom seam 2cm from the right edge of the zipper bottom stop position. Sew few reverse stitches for fixed. Increase the stitch length to maximum, set the tension below 2 and baste the remaining length of the fabric.

Press open the seam allowance. Place the zipper face down on the seam allowance with the teeth against the seam line. Baste the zipper tape in place.

- ① Wrong side
- ② 2cm
- ③ 5mm
- ④ Basting
- ⑤ Reverse stitches

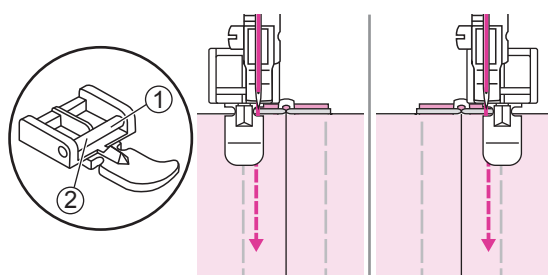

Attach the zipper foot.

- ① Attach the right pin for sewing the left side of the zipper.
- ② Attach the left pin for sewing the right side of the zipper.

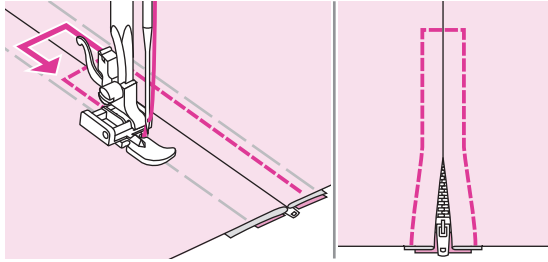

Stitching around the zipper. Remove the basting and press.

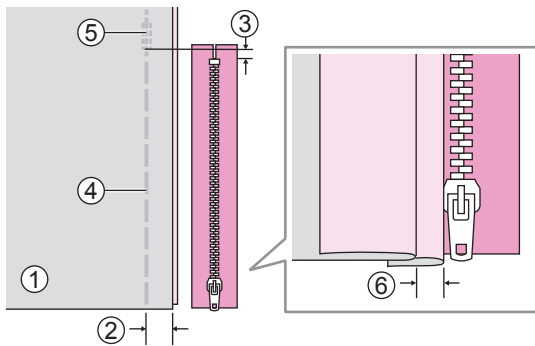

❖ Inserting a side zipper

Place the right sides of the fabric together. Sew a bottom seam 2cm from the right edge of the zipper bottom stop position. Sew few reverse stitches for fixed. Increase the stitch length to maximum, set the tension below 2 and baste the remaining length of the fabric.

Fold back to the left the seam allowance. Turn under the right the seam allowance to form a 3mm fold.

- ① Wrong side
- ② 2cm
- ③ 5mm
- ④ Basting
- ⑤ Reverse stitches
- ⑥ 3mm

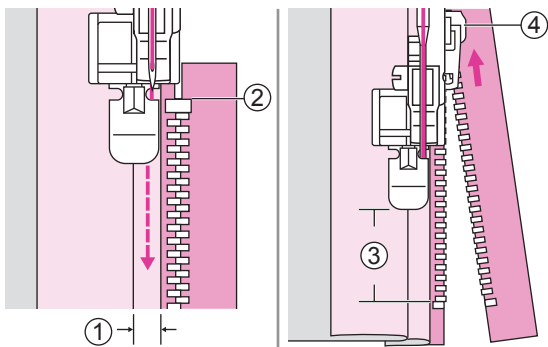

Attach the zipper foot. Attach the right pin for sewing the left side of the zipper. Sew the zipper to the piece of fabric with the extra 3mm, starting from the end of the zipper.

Stop the machine about 5cm from the top of the zipper. Lowered the needle into the fabric, raise the presser foot lifter, and then open the zipper and continue sewing.

- ① 3mm
- ② The end of zipper
- ③ 5cm
- ④ Zipper

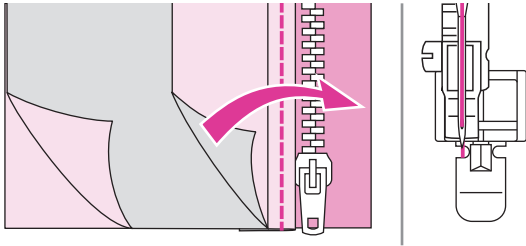

Turn the fabric right side out. Attach the left pin for sewing the rightside of the zipper.

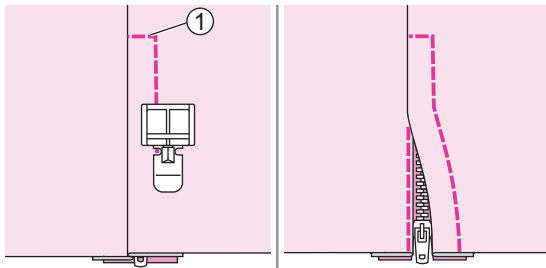

Stitch across the lower end and the right side of the zipper.

① Lower end

Stop the machine about 5cm from the top of the zipper. Remove the basting and open the zipper. Stitch the remaining of the seam.

Satin stitch sewing

Use the satin stitch foot for satin stitching and sewing decorative stitches.

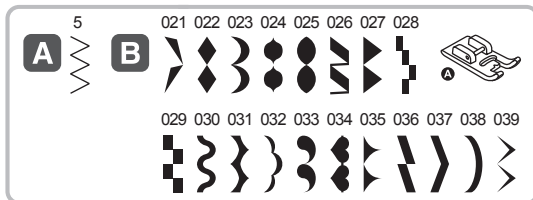

Using the satin stitch foot.

Note

When sewing very lightweight fabrics, it is recommended that you use interfacing or stabilizer on the wrong side of the fabric.

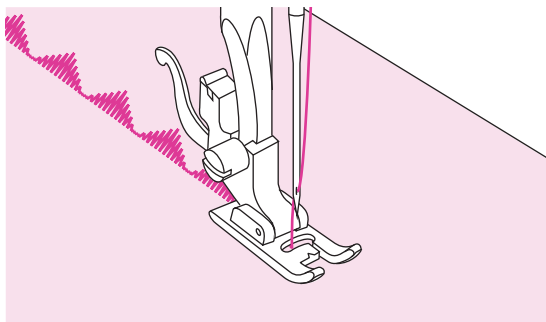

This foot has a groove on the underside which allows dense stitching to pass freely underneath.

To sew the satin or decorative stitch, you may adjust the length and width of the stitch. Experiment with fabric scraps until you get the desired length and width.

Gathering

The Gathering Foot is used for gathering fabrics. Ideal for clothing as well as home decor. It works best on thin to medium weight fabrics.



Using the gathering foot.

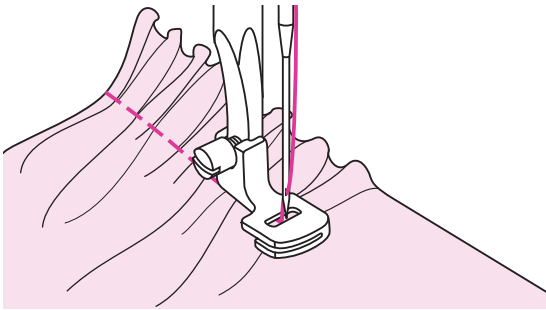

❖ Gathered fabric

Remove the presser foot holder and attach gathering foot, set the tension below 2. Place fabric to be gathered under presser foot to the right of the presser foot.

Sew a row of stitching, keeping the raw edge of fabric aligned with the right edge of foot. The stitches automatically cause the fabric to gather.

Suitable for light to medium weight fabrics. If your fabric is light, such as batiste or lace, you will have more gathers.

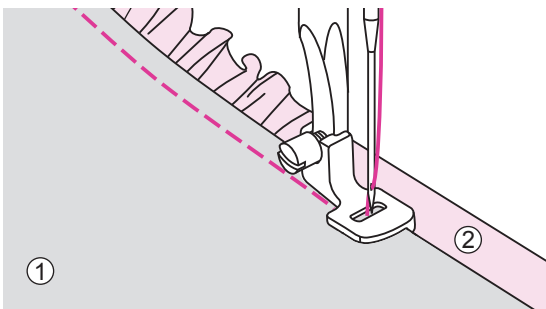

❖ To gather and attach gathered fabric in one step

Look closely at the gathering foot to see a slot on the bottom. When using the slot, you can gather the bottom layer of the fabric while attaching it to a flat top layer, such as the waistband on a dress bodice.

Remove the presser foot holder and attach gathering foot. Place the fabric to be gathered with right side up under the foot. Place top layer of the fabric right side down in the slot. Guide the two layers as illustrated. Turn the top layer of fabric right side out.

- ① Top layer of fabric (wrong side)
- ② Bottom layer of fabric (right side)

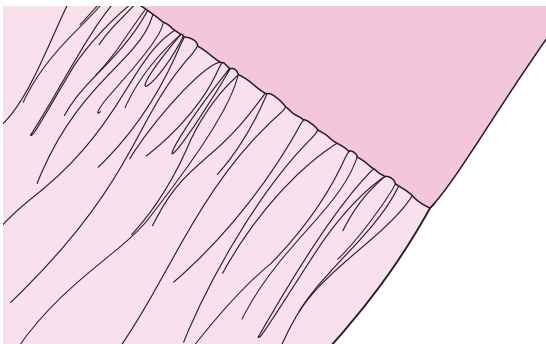

Note

Please use the same fabric of the project and do a sewing test in advance. When testing machine for adjustments to achieve desired fullness, work with 25cm of the fabric, trims or elastic. This makes it easier to determine the adjustments and how much change is needed for your project

Sew slow to medium speed for better fabric control.

Smocking

The decorative stitch created by stitching or embroidering over gathers is called "smocking". It is used to decorate the front of blouses or cuffs. The smocking stitch adds texture and elasticity to the fabric.

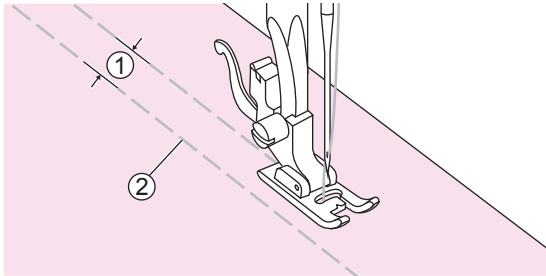
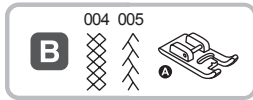

Using the satin stitch foot.

Increase the stitch length to maximum, set the tension below 2 and basting lines 1cm across the area to be smocked.

- ① 1cm
- ② Basting

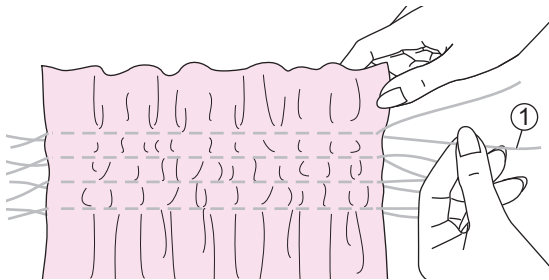

Knot the threads along one edge.

Pull the bobbin threads and distribute the gathers evenly. Secure the threads at the other end.

- ① Bobbin thread

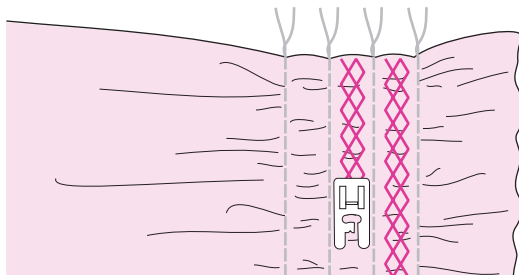

Reduce the tension if necessary and sew decorative stitches between the straight seams.

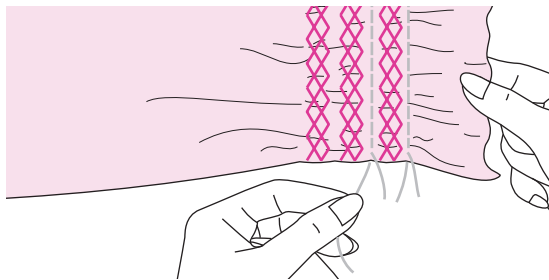

Pull out the basting.

Free motion darning, embroidery and monogramming

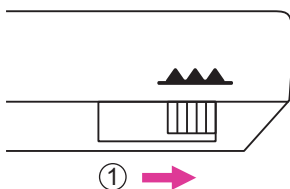
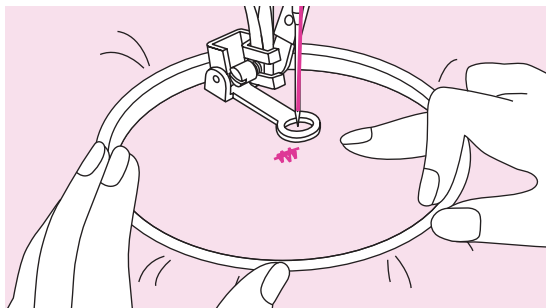
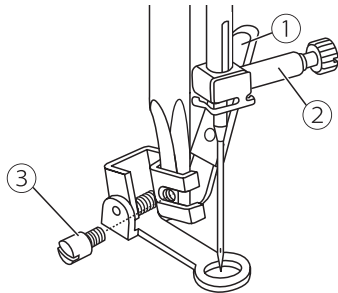
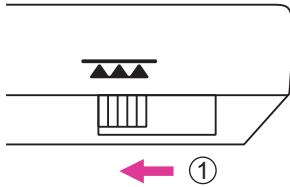
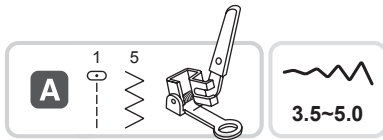

❖ Preparation for embroidering and monogramming

* Embroidery hoop is not included with the machine.

Move the drop feed lever to lower the feed dogs.

① Lowered position

Remove the presser foot and the presser foot holder, and attach the darning foot to the presser foot holder bar.

The lever should be behind the needle clamp screw. Press the darning foot on firmly from behind with your index finger and tighten the screw.

① Lever

② Needle clamp screw

③ Screw

Draw the desired lettering or design on the surface of the fabric.

Stretch the fabric between the embroidery hoop as firmly as possible.

Place the fabric under the needle. Make sure the presser foot bar is down to its lowest position.

Turn the handwheel towards you to bring up the bobbin thread through the fabric. Sew a few securing stitches at the starting point.

Hold the hoop with thumb and forefinger of both hands while pressing the material with the middle and third finger and supporting the outside of the hoop with your small finger.

⚠ Attention

Keep fingers away from moving parts, especially needles.

Note

When you finish the work, move the drop feed lever to raise the feed dogs.

① Raised position

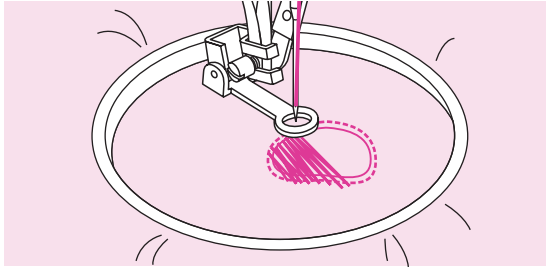

❖ Darning

First sew around the edges of the hole to secure the threads. Working from left to right, sew over the hole in a constant and continuous movement.

Turn the work by 1/4 and sew over the first stitching moving the work slower over the hole to separate the threads and not form big gaps between the threads.

Note

Free motion darning is accomplished without the sewing machine internal feed system. Movement of the fabric is controlled by the operator. It is necessary to coordinate sewing speed and movement of fabric.

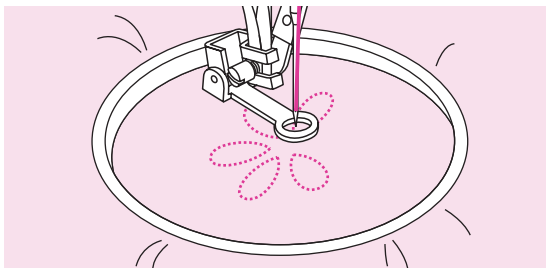

❖ Embroidery

Stitch along the outline of the design by moving the embroidery hoop. When sewing, make sure to maintain a constant speed.

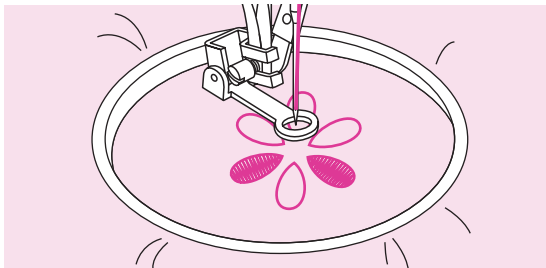

Fill in the design working from the outline towards the inside. Keep the stitches close together.

You will get longer stitches by moving the hoop faster and shorter stitches by moving the hoop slower.

Secure with reinforcement stitches at the end of the design.

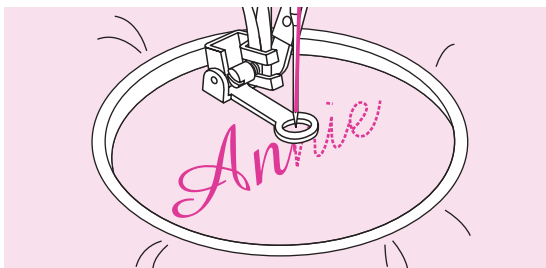

❖ Monogramming

Sew at constant speed, moving the embroidery hoop slowly along the lettering.

When the letter is finished, secure with reinforcement stitches at the end of the design.

Quilting

Sandwich batting between the top and bottom layers of fabric is call "Quilting". The top layer is usually formed by multiple geometrically shaped pieces of materials joined together.

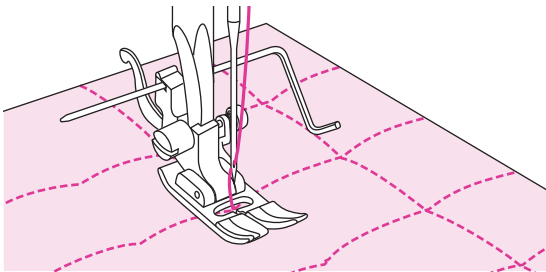
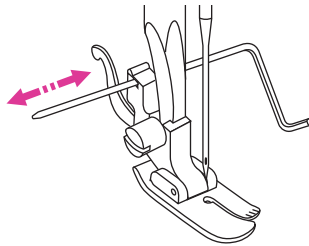
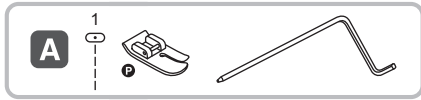

Using the Quilting foot with edge/quilting guide.

⚠ Attention

Only center straight stitches are applicable while using quilting foot.

❖ Using the edge/quilting guide

Attach the edge/quilting guide in the presser foot holder as illustrated and set the space as you desire.

Sew the first row and move over the fabric to sew successive rows with the guide riding along the previous row of stitching.

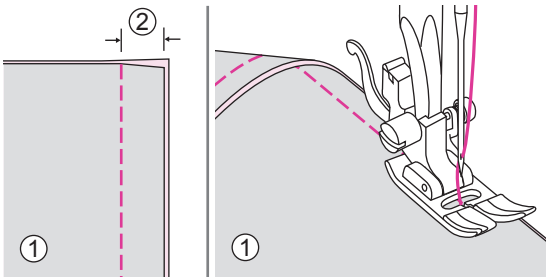

Using the all purpose foot.

❖ Joining the pieces of the fabric

Place the two pieces of fabric with the right side together and sew with the straight stitch.

Join the pieces of fabric with a seam allowance of 5mm.

Sew with the side of the presser foot aligned with the edge of the fabric.

- ① Wrong side
- ② 5mm



Using the all purpose foot or satin stitch foot..

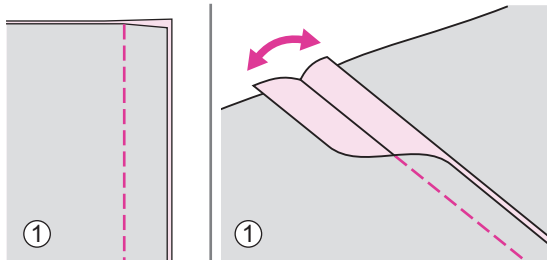

❖ Patchwork stitching

Place the two fabrics, right sides together and sew using a straight stitch.

Open the seam allowance and press it flat.

① Wrong side

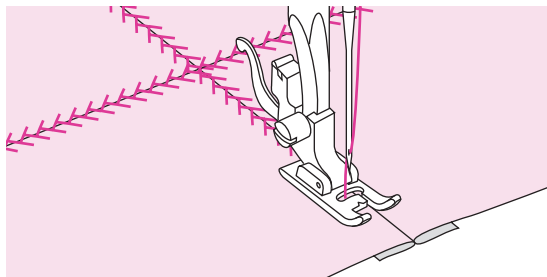

Working on the right side of the fabric, place the center of the presser foot on the seam line of the joined fabrics and stitch over the seam.

Applique

You can create and applique by cutting a different piece of fabric into a shape and using it as a decoration.

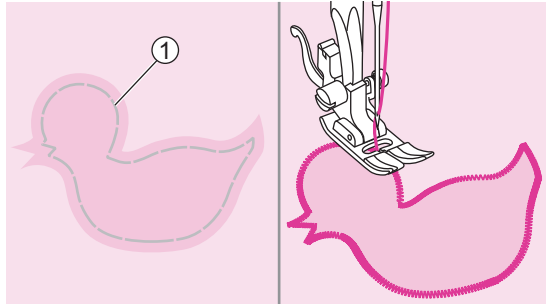

Using the all purpose foot.

Cut out the applique design and baste it on the fabric. Sew slowly around the edge of the design.

① Basting

Trim the excess material outside the stitching. Make sure not to cut any stitches. Remove the basting.

Fagoting

Stitching across an open seam is called "fagoting". It is used on blouses and children's clothing. This stitch is more decorative when thicker thread is used.

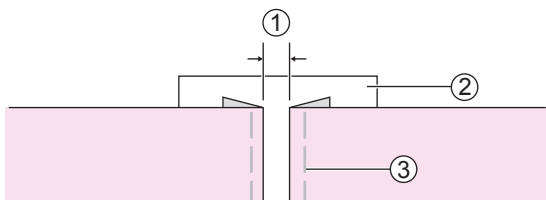
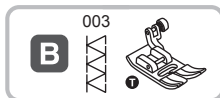

Using the all purpose foot.

Separate the folded edges of the fabric pieces with a gap of 4mm and baste them onto a piece of thin paper or water-soluble stabilizer sheet.

- ① 4mm
- ② Thin paper or water-soluble stabilizer
- ③ Basting

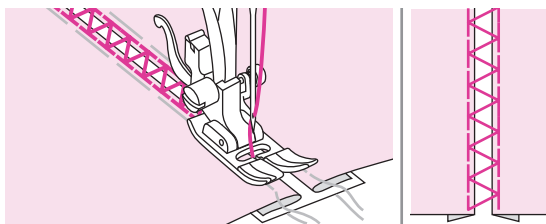

Align the center of the presser foot with the center of the two pieces of fabric and begin sewing.

After sewing, remove the stabilizer and basting.

Scallop stitch

The wave-shaped repeating stitch, that looks like shells, is called "scalloping". It is used to decorate the collar of blouses and the edges of knitting projects.

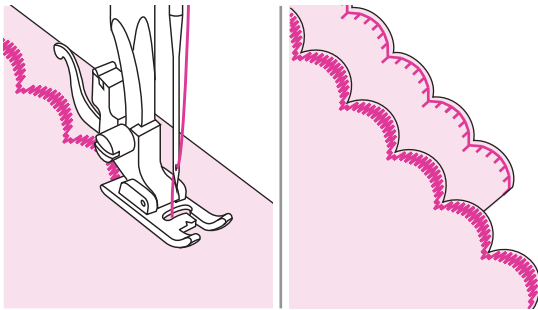

Using the satin stitch foot or all purpose foot.

❖ Scallop edging

Stitch along the edge of the fabric, making sure not to sew directly on the edge of the fabric.

For better results, apply spray starch onto the fabric and press with a hot iron before it is sewn.

Trim the fabric close to the stitching taking care not to cut the stitches.

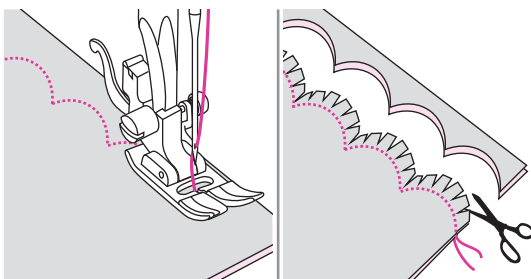
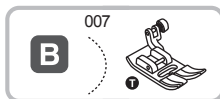

Using the all purpose foot.

❖ Scallop hem

Fold the fabric right side together. Sew along the folded edge as illustrated.

Cut the fabric along the seam leaving an allowance of 3mm for seaming.

Notch the allowance.

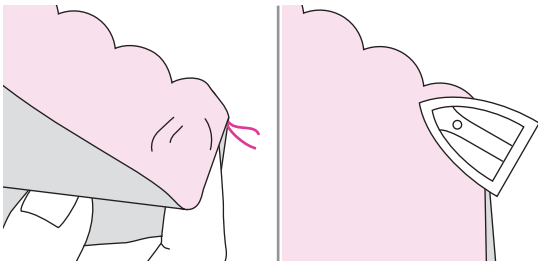

Turn the fabric over and push out the curved seam to the surface and iron it.

Cording

Used for embellishing 1 to 3 cords or decorative threads. Sew over one strand of cording to create a pretty swirled design on a jacket or vest or sew over three strands of cording for border trims. Pearl cotton, knitting yarn, embroidery floss, lace thread, fine wool or lily yarn can be used for cording.

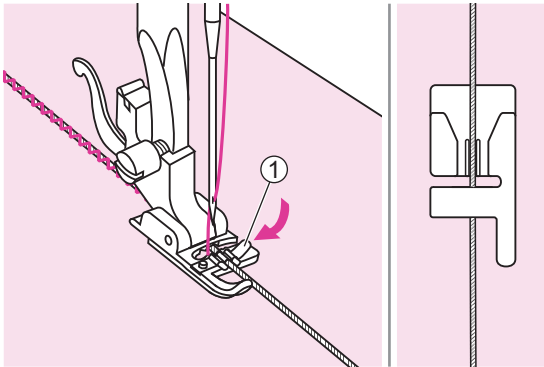
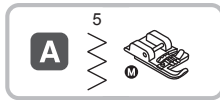

Using the cording foot.

❖ Single cording

Mark the design on the fabric. Insert the cord in the center groove of the cording foot from the right side opening.

① Right side opening

Place the cord under the grooves of the cording foot and pull the cord about 5cm behind the foot.

The grooves under the foot will hold the length of the cord in place while the stitches are being formed over the cord.

Select the stitch and adjust the stitch width so that the stitches are just covering the cord. Lower the presser foot lifter and sew slowly, guiding the cord over the design.

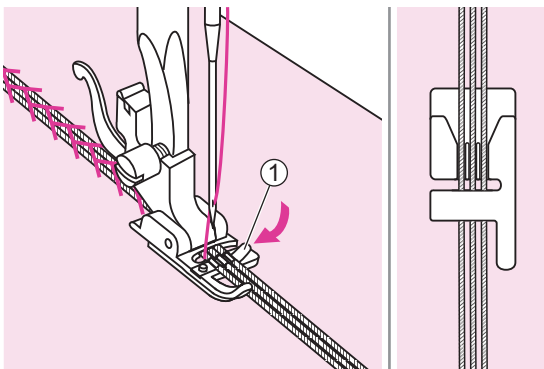
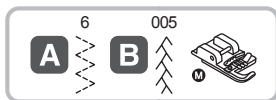

Using the cording foot.

❖ Striple cording

Mark the design on the fabric. Insert the cord in the center groove of the cording foot from the right side opening.

Place the cord under the grooves of the cording foot and pull the cord about 5cm behind the foot.

The grooves under the foot will hold the length of the cord in place while the stitches are being formed over the cord.

Select the stitch and adjust the stitch width so that the stitches are just covering the cord. Lower the presser foot lifter and sew slowly, guiding the cord over the design.

Narrow hemming

The hemmer foot is used to stitch the narrow rolled hems usually found on shirt tails, table linens and along the edge of frills.

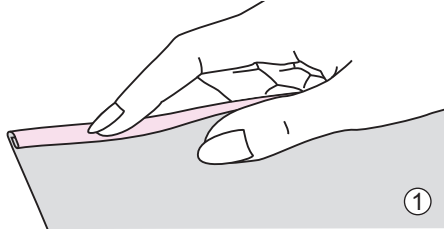

Using the hemmer foot.

Fold edge of fabric over about 3mm, then fold it over again 3mm for about 5cm along the edge of the fabric.

① Wrong side

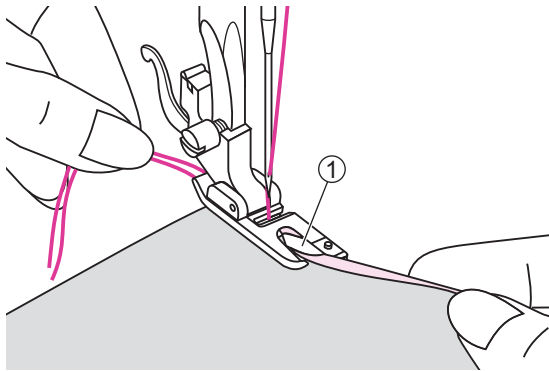

Insert the needle into the fold by turning the handwheel toward you, and lower the presser foot lifter. Sew several stitches and raise the presser foot lifter.

Insert the fabric fold into the spiral opening of hemmer foot. Move fabric back and forth until the fold forms a scroll shape.

① Scroll shape of the hemmer foot

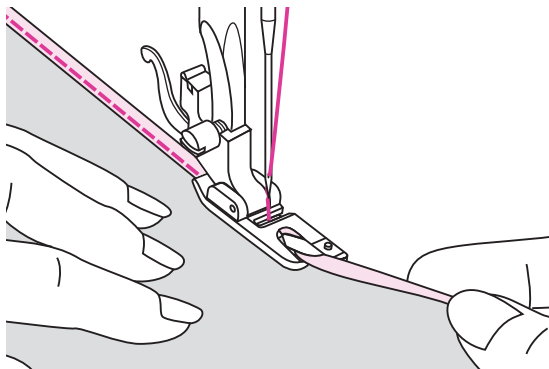

Lower the presser foot lifter and start sewing slowly guiding the raw edge of the fabric in front of the hemmer foot evenly into the scroll of the foot.

Twin needle

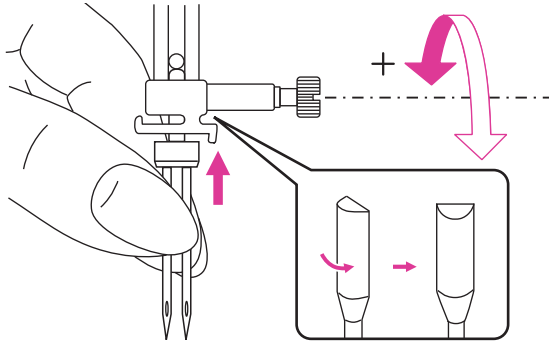
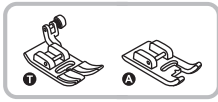

Using the all purpose foot or satin stitch foot

Insert the twin needle. Please refer to "Replacing the needle" chapter for more information. (Page 14)

⚠ Attention

When using the twin needle, be sure to select the twin needle setting and attach the suggested presser foot which screen appears.

Use only twin needle assemblies with max. 2.5mm needle distance, 80/12 needle size.

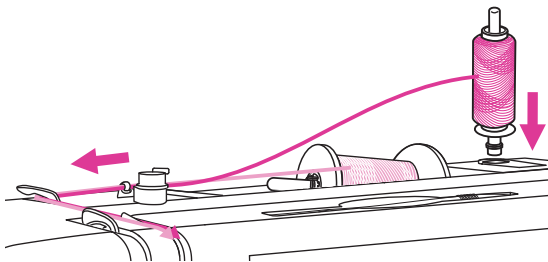

Follow the instructions for single-needle threading using the horizontal spool pin. Thread through the left needle.

Set the second spool pin into the hole on the top of the machine. Thread through remaining points, making certain to omit the thread guide above the needle and pass thread through the right needle.

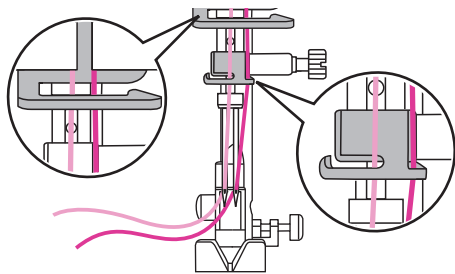

Thread each needle separately.

Note

Make sure that the two threads used to thread the twin needle are of the same weight. You can use one or two colors.



Select a stitch for twin needle. Please refer to "Stitch chart" chapter. (Page 34)

Press the twin needle button, the LCD screen will display the twin needle icon.

The machine automatically reduces the maximum width for the twin needle sewing.

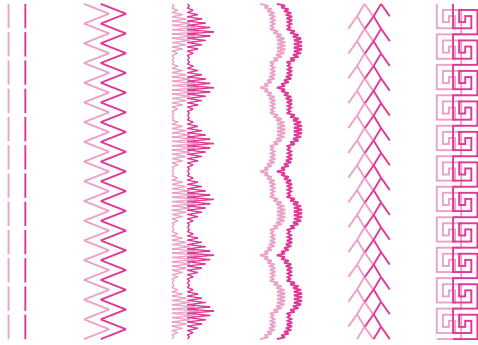

Two lines of stitching are sewn parallel to each other.

Note

When sewing with twin needle, always proceed slowly, and make sure to maintain a low speed to insure quality stitching.

When twin needle sewing has been selected, it will remain active even the stitch is changed.

Twin needle function cannot be used under memory mode.

If the sewing machine is turned off, the sewing function returns to its default setting.



Maintenance and Trouble shooting



Maintenance

⚠ Attention

Disconnect the power cord from the wall socket before carrying out any maintenance, otherwise injury or electrical shock may result.

❖ Clean the machine surface

If the surface of the sewing machine is dirty, lightly soak a cloth in mild detergent, squeeze it out firmly and then wipe the surface. After cleaning it once in this way, wipe the surface again with a dry cloth.

Do not use any organic solvents or detergents

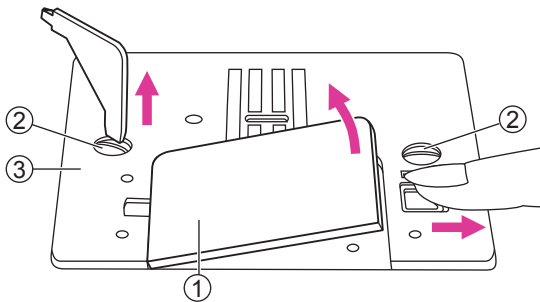

❖ Clean the hook

If lint and bits of thread accumulate in the hook, this will interfere with the smooth operation of the machine. Check regularly and clean the stitching mechanism when necessary.

Remove the needle, presser foot and presser foot holder.

Remove the bobbin cover and bobbin.

Remove the screws on the needle plate then remove the needle plate.

- ① Bobbin cover
- ② Screws
- ③ Needle plate

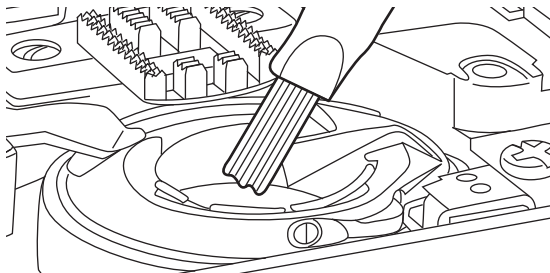

Clean the feed dogs and bobbin case with a brush. And also use a soft and dry cloth to clean them.

Warning Function



❖ Warning beeping sound

- Operate correctly: 1 beep.
- Operate incorrectly: 2-short beeps.
- When the sewing machine is in trouble and can't sew: 3-short beeps.

It means that the thread may be twisted or jammed and the handwheel axle can't move. Please look through the "Trouble shooting guide" to find the solution. After the problem has been solved, the machine will be able to sew.

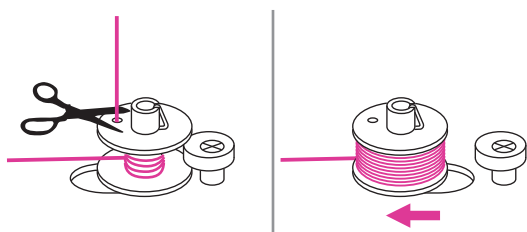

Return bobbin winder spindle to left

When the bobbin thread is full or machine stop, if the bobbin winder spindle is still in the right position, you will hear 3-short beeps by pressing any button until you push the spindle to the left.

Return the bobbin winder spindle to the left.

Note

If the problem is still not solved, please contact your local dealer.

⚠ Attention

During sewing, if the thread has been jammed inside the hook and needle movement stops. If you continue to sew, the machine will stop automatically due to safety. If machine stops, please turn off the machine firstly then turn on again.

Trouble shooting guide

Before calling for service, check below trouble shooting guides in advance, if problem still exist, please contact nearest dealer or local service center.

Problem	Cause	Correction	Reference
Upper thread breaks	1. The machine is not threaded correctly.	1. Rethread the upper thread.	10
	2. The thread tension is too tight.	2. Reduce the thread tension (to lower number).	18
	3. The thread is too thick for the needle.	3. Select a larger needle size.	15
	4. The needle is not inserted correctly.	4. Remove and reinsert the needle (flat side towards the back).	14
	5. The thread is wound around the spool holder pin.	5. Remove the reel and wind up the thread onto the reel.	7
	6. The needle is damaged.	6. Insert a new needle.	14
Bobbin thread breaks	1. The bobbin case is not inserted correctly.	1. Remove and reinsert the bobbin case and pull on the thread.	7
	2. The bobbin case is threaded wrong.	2. Check both bobbin and bobbin case if on the correct position.	7
Skipped stitches	1. The needle is not inserted correctly.	1. Remove and reinsert the needle (flat side towards the back).	14
	2. The needle is damaged.	2. Insert a new needle.	14
	3. The wrong size needle has been used.	3. Choose a needle to suit the thread.	15
	4. The presser foot is not attached correctly.	4. Check and attach it correctly.	16
	5. The machine is not threaded correctly.	5. Rethread the upper thread.	10
Needle breaks	1. The needle is damaged.	1. Insert a new needle.	14
	2. The needle is not correctly inserted.	2. Insert the needle correctly (flat side towards the back).	14
	3. Wrong needle size for the fabric.	3. Choose a needle to suit the thread and fabric.	15
	4. The wrong presser foot is attached.	4. Select the correct presser foot.	-
	5. The needle clamp screw is loose.	5. Use the screwdriver to tighten the screw.	14
	6. The presser foot is not appropriate for the type of stitch that you sew.	6. Attach appropriate presser foot for the type of stitch that you sew.	-
	7. The upper thread tension too tight.	7. Loosen the upper thread tension.	18

Problem	Cause	Correction	Reference
Loose stitches	1. The machine is not correctly threaded.	1. Check the threading and rethread.	10
	2. The bobbin case is not threaded correctly.	2. Thread the bobbin case as illustrated.	7
	3. Needle/fabric/thread combination is wrong.	3. The needle size must suit the fabric and thread.	15
	4. The thread tension is wrong.	4. Correct the thread tension.	18
Seam gather or pucker	1. The needle is too thick for the fabric.	1. Select a correct needle size.	15
	2. The stitch length is wrong.	2. Adjust the stitch length.	24
	3. The thread tension is too tight.	3. Loosen the thread tension.	18
Seam puckering	1. The needle thread tension is too tight.	1. Loosen the thread tension.	18
	2. The needle thread is not threaded correctly.	2. Rethread the machine.	10
	3. The needle is too heavy for the fabric being sewn.	3. Choose a needle to suit the thread and fabric.	15
	4. The stitch length is too long for the fabric.	4. Adjust the stitch length shorter.	24
	5. Sewing on thin fabric.	5. Sew with a stabilizer material under the fabric.	42
stitches are distorted	1. The presser foot is not suited for the stitch.	1. Select the correct foot.	-
	2. The needle thread tension is too tight.	2. Loosen the thread tension.	18
Thread has jammed	1. Thread is caught in the hook.	Remove the upper thread and bobbin case, turn the handwheel backwards and forwards and remove the thread remnants.	74
	2. The feed dogs are packed with lint.		
The machine is noisy	1. Fluff or oil have collected on the hook or needle bar.	1. Clean the hook and feed dog.	74
	2. The needle is damaged.	2. Insert a new needle.	14
	3. Thread is caught in the hook.	Remove the upper thread and bobbin case, turn the handwheel backwards and forwards and remove the thread remnants.	74
	4. The feed dogs are packed with lint.		
Uneven stitches, uneven feed	1. Poor quality thread.	1. Select a better quality thread.	15
	2. The bobbin case is threaded uncorrect.	2. Remove the bobbin case and the thread and reinsert them correctly.	7
	3. Fabric has been pulled on.	3. Do not pull on the fabric while sewing, let it be taken up by the machine.	-

Problem	Cause	Correction	Reference
The sewing machine doesn't operate	1. The machine is not turned on.	1. Turn on the machine.	3
	2. The presser foot lifter is raised.	2. Lower the presser foot lifter.	5
	3. The machine is not plugged in.	3. Connect the power cord to the electric outlet.	3

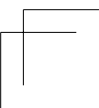
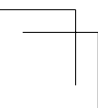



Do not dispose of electrical appliances as unsorted municipal waste, use separate collection facilities.

Contact your local government for information regarding the collection systems available.

If electrical appliances are disposed of in landfills or dumps, hazardous substances can leak into the groundwater and get into the food chain, damaging your health and well-being.

When replacing old appliances with new ones, the retailer is legally obligated to take back your old appliance for disposal at least for free of charge.